

Meeting tables Tack technical specification



.mdd

.mdd has a leading position among manufacturers of office furniture with many awards that prove quality and continuously increase demand for it's products.

The realities of today`s market require constant quality improvement at all levels of modern organization. This applies in particular to customer service, marketing, quality of products and also to quality of processes within the company.

Partnership relations among employees and with business partners form a base of economic growth and success of the company.

Constant investments in innovative machinery park, optimization of management systems and an expansion of production halls allow to minimize the lead times for the product of the highest quality.

More than twenty years of experience in office furniture industry come with reference from a long list of companies and institutions to show their appreciation for an efficient and comprehensive service. .mdd is highly aware of the environment.

Being located in the forest region with lake by it's side, .mdd takes the nature seriously and invests constantly in a modern and energy-efficient solutions to preserve the local life. Company puts emphasis on waste segregation and recycling. .mdd has been awarded for the exceptional care and involvement in waste disposal. All materials used are environmentally friendly and enjoy a high 95 % rate of being recycled.



General informations:

Warranty:

.mdd products - **5 years.**

Electrical components and fabric - **2 years.**

Certificate - MFC:



Boards density:

12 mm - 690 - 750 kg/m³

18 mm - 650 - 690 kg/m³

28 mm - 610 - 630 kg/m³

36 mm - 610 - 630 kg/m³

Assembly:

product delivered in separate elements

Packing:

cartboard, perforated plastic mesh wrap

Meeting tables

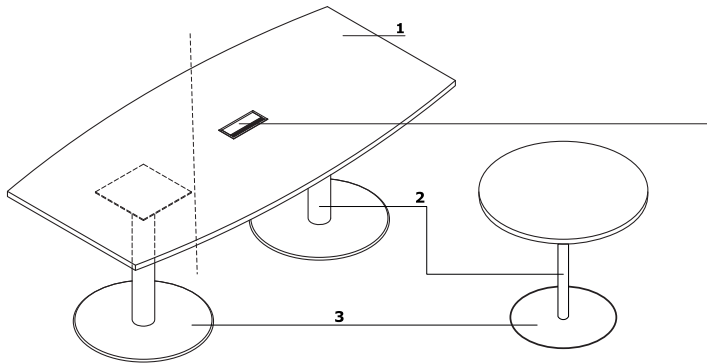

- 1. **Worktop** - MFC 28 mm, ABS edge
- 2. **Column** - powder coated steel
- 3. **Disc** - stainless steel INOX, powder coated

OPTIONS WITH EXTRA CHARGE:

- 4. **Mediabox M04H** - 2xRJ45 (class E, cat. 6); +1 x USB + 1 x HDMI + 4x 230V, mediabox colour is matched to the colour of the frame
- 5. **Mediabox M04** - 2xRJ45 (class E, cat. 6); +1 x USB + 4x 230V, mediabox colour is matched to the colour of the frame
- 6. **Top access M05** - top access colour is matched to the colour of the frame
- 7. **Mediabox cut - out** - mediabox has to be selected separately

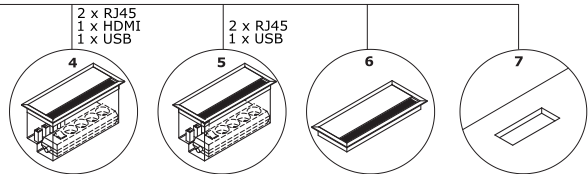

Chairs arrangement

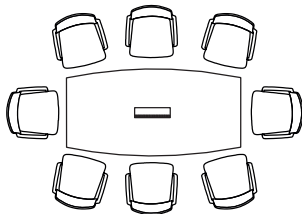

ST12P

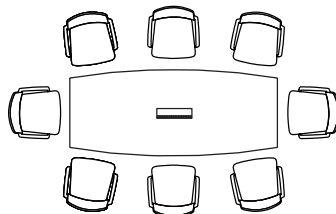

ST24

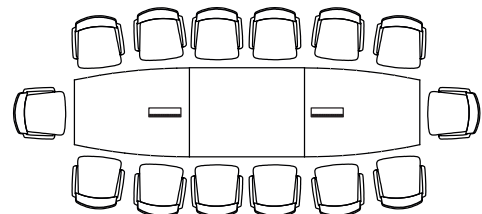

2x ST14, ST14S

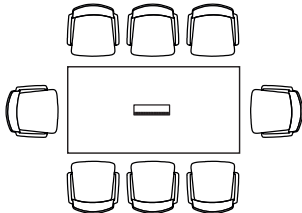

ST12PK

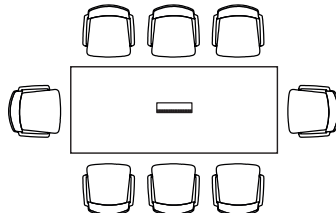

ST24K

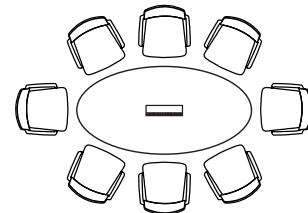

ST12E

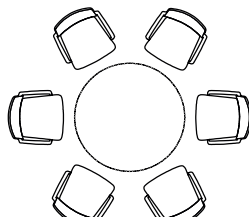

ST12

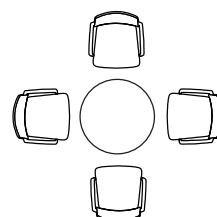

ST08

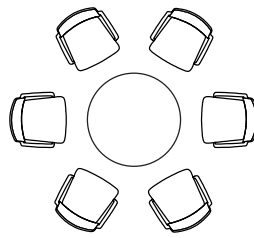

ST10

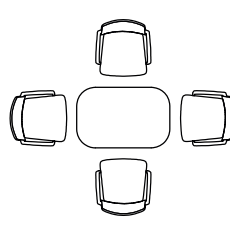

ST06

Meeting tables Tack *



ST06
650 / 1000 / 730
41.45 kg



ST08
800 / 800 / 730
31.8 kg

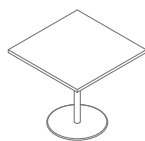

ST08K
800 / 800 / 730
33.5 kg



ST10
1000 / 1000 / 730
46 kg



ST12
1200 / 1200 / 730
53.35 kg

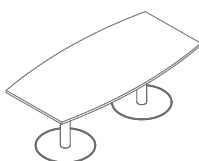

ST12P
2000 / 800-1000 / 730
96.5 kg

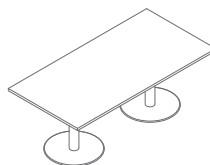

ST12PK
2000 / 800-1000 / 730
97.45 kg

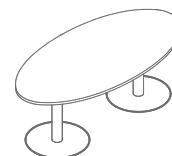

ST12E
2000 / 1000 / 730
92 kg

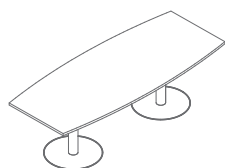

ST24
2400 / 800-1000 / 730
103.75 kg

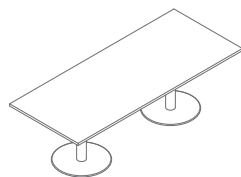

ST24K
2400 / 800-1000 / 730
104.45 kg

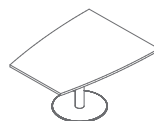

ST14
1400 / 800-1100 / 730
60.05 kg

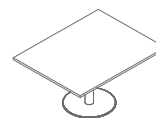

ST14S
1400 / 1100 / 730
61.1 kg



PS2
550 / 550 / 643
13.5 kg

* dimensions expressed in millimeters: width x depth x height

High tables *



PS80
800 / 800 / 1100
23 kg

Pre-defined configurations *

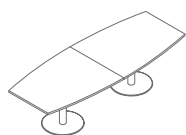

ST15
2800 / 1100-800 / 730
120.1 kg

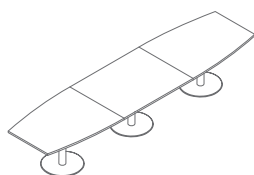

ST16
4200 / 1100-800 / 730
181.2 kg

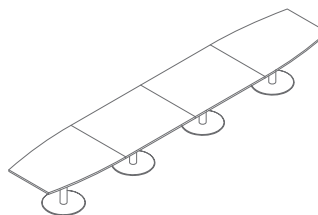

ST17
5600 / 1100-800 / 730
242.3 kg

* dimensions expressed in millimeters: width x depth x height

Meeting tables Tack	Date of preparation 01.10.2021	The data contained in this document is valid in the day of its preparation. Change of the product, as long as it does not affect the basic features of it, does not require consistent updates of the document.	page 5/6
			products

Top



Column, disc base

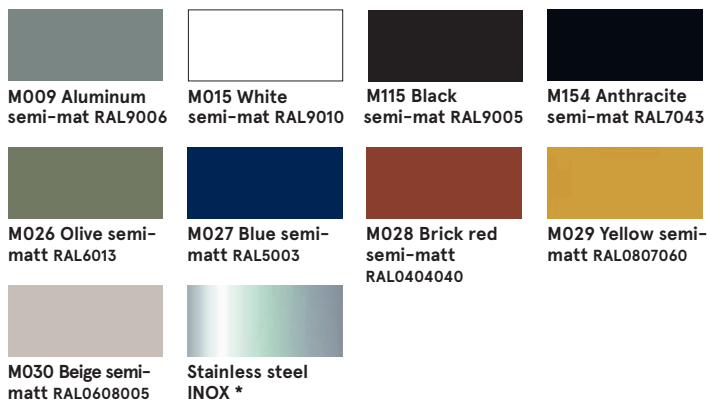

Mediabox



* column - option with extra charge