

Ogi W

technical specification



.mdd

.mdd has a leading position among manufacturers of office furniture with many awards that prove quality and continuously increase demand for it's products.

The realities of today`s market require constant quality improvement at all levels of modern organization. This applies in particular to customer service, marketing, quality of products and also to quality of processes within the company.

Partnership relations among employees and with business partners form a base of economic growth and success of the company.

Constant investments in innovative machinery park, optimization of management systems and an expansion of production halls allow to minimize the lead times for the product of the highest quality.

More than twenty years of experience in office furniture industry come with reference from a long list of companies and institutions to show their appreciation for an efficient and comprehensive service.

.mdd is higly aware of the environment.

Being located in the forest region with lake by itis side, .mdd takes the nature seriously and invests constantly in a modern and energy-efficient solutions to preserve the local life. Company puts emphasis on waste segregation and recycling. .mdd has been awarded for the exceptional care and involvement in waste disposal. All materials used are environmentally friendly and enjoy a high 95 % rate of being recycled.



General informations:

Warranty:

.mdd products – **5 years.**

Electrical components and fabric – **2 years.**

Certificate - MFC:



Compliant with standards:

PN-EN 527-2:2017-02

Boards density:

12 mm - 690 - 750 kg/m³

18 mm - 650 - 690 kg/m³

28 mm - 610 - 630 kg/m³

36 mm - 610 - 630 kg/m³

Assembly:

product delivered in separate elements

Packing:

cardboard, perforated plastic mesh wrap

Ogi W	Date of preparation 30.11.2021	The data contained in this document is valid in the day of its preparation. Change of the product, as long as it does not affect the basic features of it, does not require consistent updates of the document.	page 2/11 general informations
-------	-----------------------------------	---	--

Ogi desk worktops

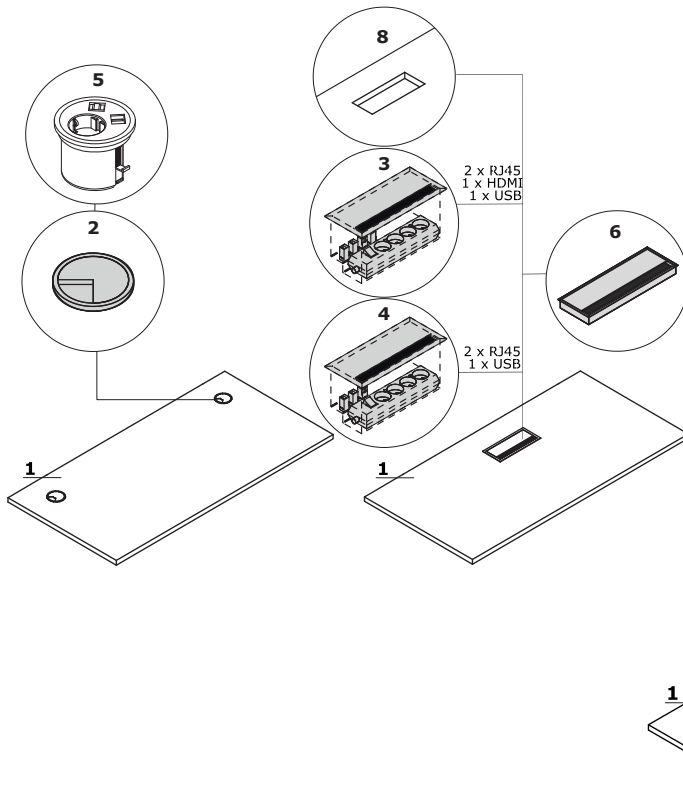

- 1. **Worktop** - MFC 28 mm, ABS edge
- OPTIONS WITH EXTRA CHARGE:**
- 2. **Grommet** - 2 pcs, Ø 80 mm
- 3. **Mediabox M04H** - 2 x RJ45 (class E, cat. 6); + 1 x USB + 1 x HDMI + 4 x 230V, mediabox colour is matched to the colour of the frame
- 4. **Mediabox M04** - 2 x RJ45 (class E, cat. 6); + 1 x USB + 4 x 230V, mediabox colour is matched to the colour of the frame
- 5. **Mediabox M07** - 1 x 230V + 1 x USB charger + 1 x RJ45, colour: black, white, mounted instead of the existing grommet Ø80 mm (PK80)
- 6. **Top access M05** - top access colour is matched to the colour of the frame
- 7. **Cable way** - the width of the opening is proportional to the width of the worktop
- 8. **Mediabox cut - out** - mediabox has to be selected separately

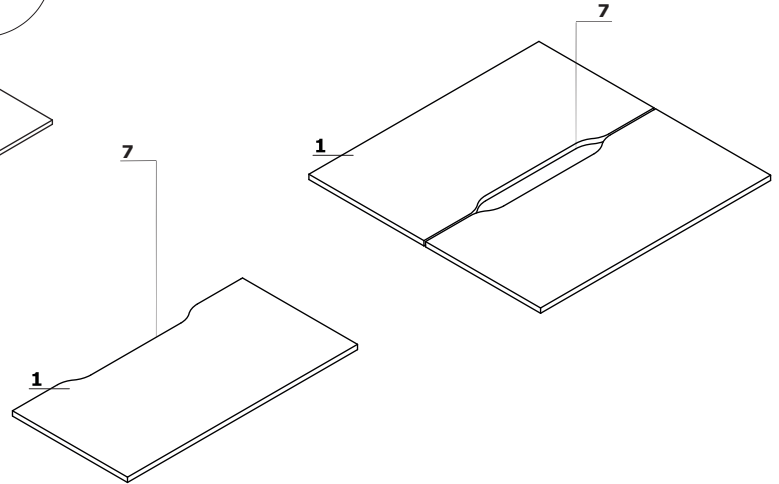

Frame

Ogi W: natural wood - ash, coated with transparent varnish, with metal element, powder coated, profile 40 x 40 mm, spacer 10 mm between top and frame

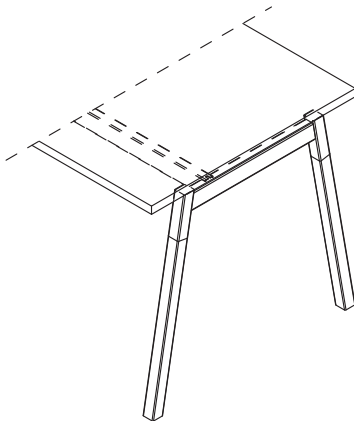

Attention - the cable tray located underneath the worktop is only available in: M009 - aluminium semi-matte colour

Ogi W	Date of preparation 30.11.2021	The data contained in this document is valid in the day of its preparation. Change of the product, as long as it does not affect the basic features of it, does not require consistent updates of the document.	page 3/11 technical description
-------	-----------------------------------	---	---

Desk with managerial storage

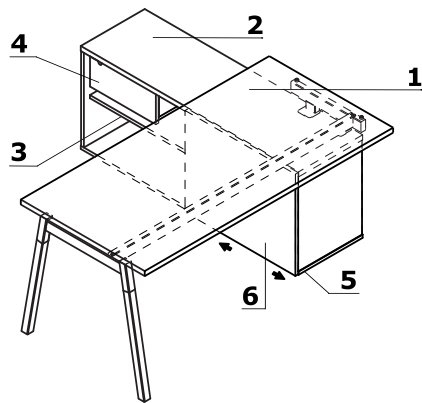

- 1. **Worktop** - MFC 28 mm, ABS edge
- 2. **Top** - MFC 28 mm, ABS edge
- 3. **Shelf** - MFC 18 mm, protection against accidental falling-out, ABS edge
- 4. **Drawer** - MFC 18 mm, ABS edge, patent lock - possible to change location
- 5. **Base** - MFC 18 mm, ABS edge
- 6. **Front** - MFC 18 mm, ABS edge

Configuration examples (mm)

www.mdd.eu

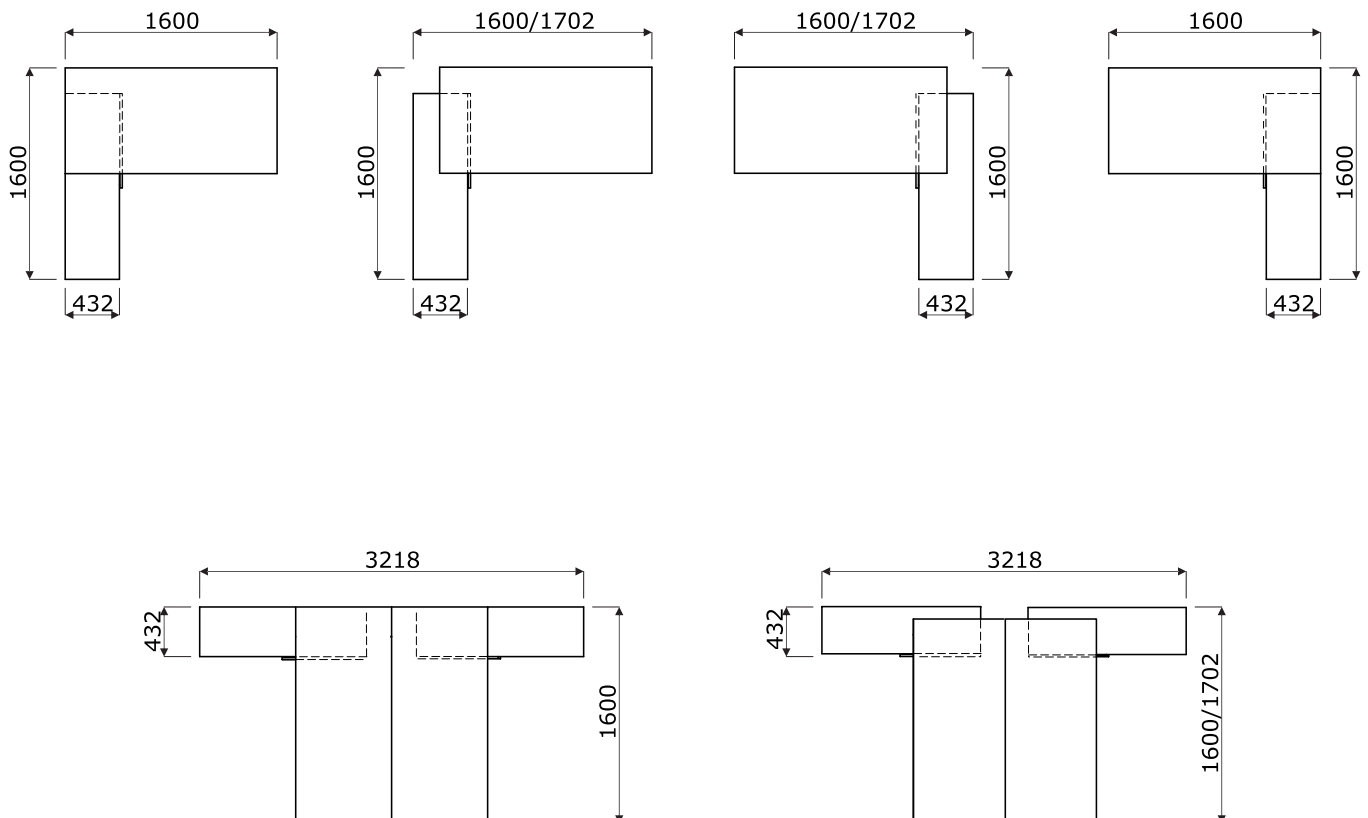

Accessories

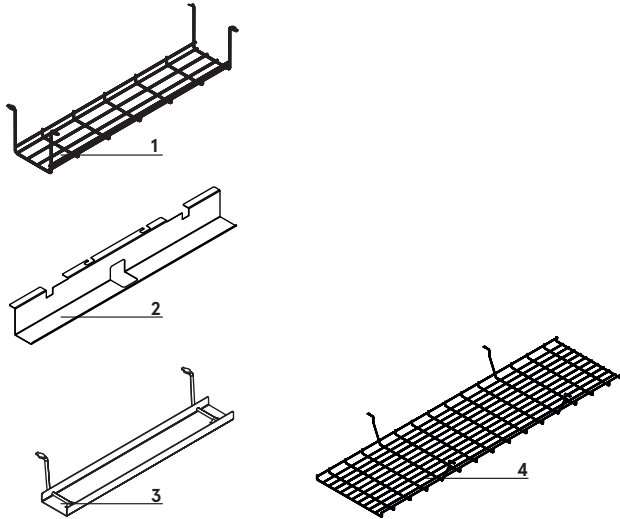

1. Horizontal cable tray S69 – powder coated, colour: 09 – aluminum
2. Single desk horizontal cable tray (SG12, SG16) – powder coated metal, colour: M009 – aluminum semi-matt
3. Horizontal cable tray E64 – powder coated, colour: M009 – aluminium semi-matt
4. Cable tray for bench desks (SG220, SG260) – steel wire Ø4 mm, powder coated, colour: 09 – aluminum

Sliding top

1. Sliding top – shifting range 141 mm

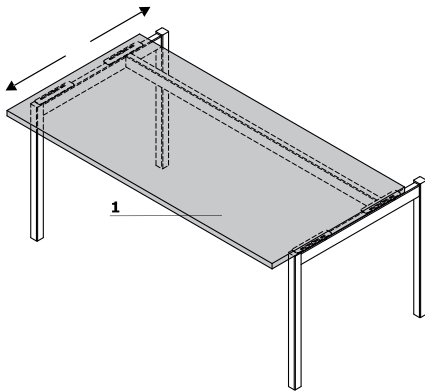

Note – M04, M04H, and M07 mediaboxes cannot be installed.

Power strip - for series connection

1. **PWS1** - set for 1 workstation - power strip (3x SCHUCKO, 2x RJ45) x1 + power cord (universal outlet PL/FR/Schucko)
2. **PWS2** - set for 2 workstation - power strip (3x SCHUCKO, 2x RJ45) x2 + set of power cords (universal outlet PL/FR/Schucko)
3. **PWS3** - set for 3 workstation - power strip (3x SCHUCKO, 2x RJ45) x3 + set of power cords (universal outlet PL/FR/Schucko)

1

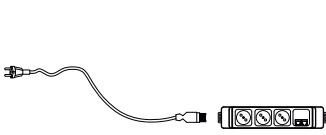

2

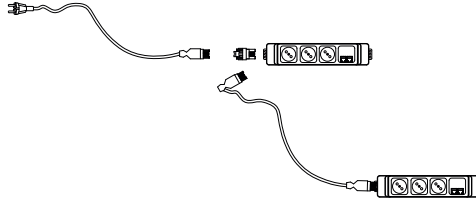

3

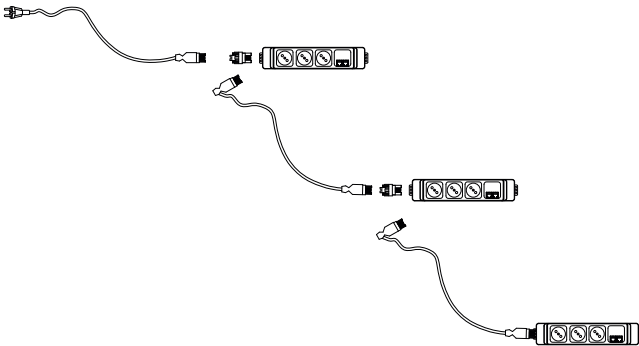

Desks *



BOW10
1000 / 600 / 740
23.3 kg



BOW12
1200 / 600 / 740
25.3 kg



BOW14
1400 / 600 / 740
44 kg

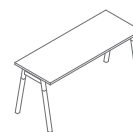

BOW16
1600 / 600 / 740
31.5 kg



BOW19
1000 / 700 / 740
23.3 kg



BOW22
1200 / 700 / 740
31 kg



BOW24
1400 / 700 / 740
57.6 kg



BOW26
1600 / 700 / 740
36.15 kg

www.mdd.eu



BOW02
1200 / 800 / 740
34 kg



BOW03
1400 / 800 / 740
36.5 kg



BOW04
1600 / 800 / 740
41.55 kg



BOW05
1800 / 800 / 740
45.55 kg



BOW06
2000 / 800 / 740
45.55 kg



BOW07
1000 / 1000 / 740
56.7 kg

* dimensions expressed in millimeters: width x depth x height

Ogi W	Date of preparation 30.11.2021	The data contained in this document is valid in the day of its preparation. Change of the product, as long as it does not affect the basic features of it, does not require consistent updates of the document.	page 7/11
			products

Elements for arrangement building - straight desk, natural wood *

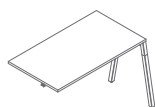

BOW22L
1200 / 700 / 740
26.9 kg

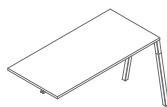

BOW24L
1400 / 700 / 740
28.5 kg

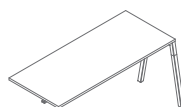

BOW26L
1600 / 700 / 740
32.05 kg

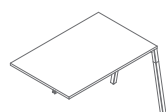

BOW02L
1200 / 800 / 740
29.2 kg

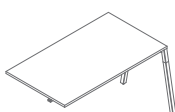

BOW03L
1400 / 800 / 740
31.7 kg

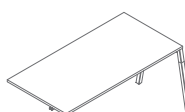

BOW04L
1600 / 800 / 740
36.75 kg

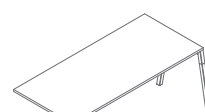

BOW05L
1800 / 800 / 740
40.75 kg

Bench desks *

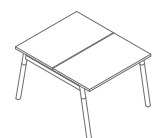

BOW50
1000 / 1210 / 740
41.6 kg

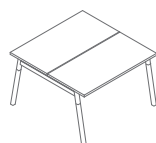

BOW52
1200 / 1210 / 740
45.6 kg



BOW54
1400 / 1210 / 740
51 kg



BOW56
1600 / 1210 / 740
58 kg

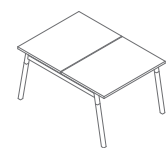

BOW48
1000 / 1410 / 740
42.6 kg

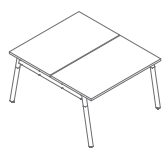

BOW42
1200 / 1410 / 740
58 kg

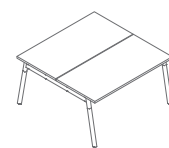

BOW44
1400 / 1410 / 740
61.2 kg

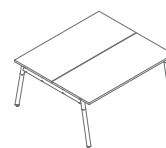

BOW46
1600 / 1410 / 740
68.3 kg

* dimensions expressed in millimeters: width x depth x height

Ogi W	Date of preparation 30.11.2021	The data contained in this document is valid in the day of its preparation. Change of the product, as long as it does not affect the basic features of it, does not require consistent updates of the document.	page 8/11
			products

Bench desks *

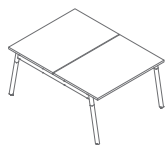

BOW32
1200 / 1610 / 740
63 kg

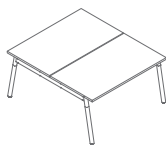

BOW33
1400 / 1610 / 740
68 kg

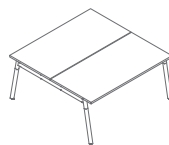

BOW34
1600 / 1610 / 740
78.1 kg

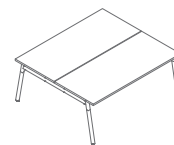

BOW35
1800 / 1610 / 740
86.1 kg

Elements for arrangement building - bench, natural wood *

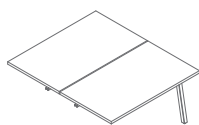

BOW42L
1200 / 1410 / 740
52.2 kg

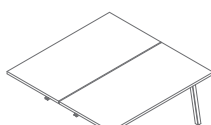

BOW44L
1400 / 1410 / 740
55.4 kg

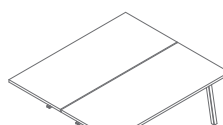

BOW46L
1600 / 1410 / 740
62.5 kg

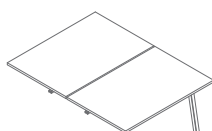

BOW32L
1200 / 1610 / 740
56.8 kg

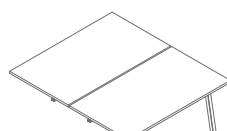

BOW33L
1400 / 1610 / 740
61.8 kg

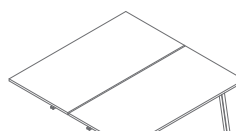

BOW34L
1600 / 1610 / 740
71.9 kg

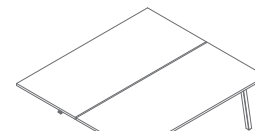

BOW35L
1800 / 1610 / 740
79.9 kg

Desks with managerial storage *

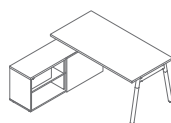

BOW20
1702-1600 / 1600 / 740
102.25 kg

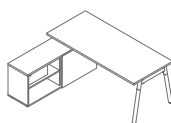

BOW21
1902-1800 / 1600 / 740
104.65 kg

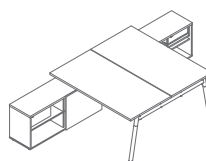

BOW40
1702-1600 / 3210 / 740
199.3 kg

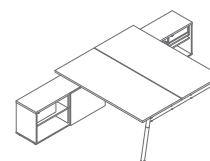

BOW41
1902-1800 / 3210 / 740
207.3 kg

* dimensions expressed in millimeters: width x depth x height

Desk extensions *

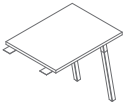

PLW01
600 / 800 / 740
15.05 kg

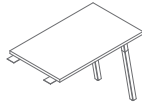

PLW02
600 / 1000 / 740
16.05 kg

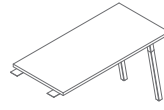

PLW03
600 / 1200 / 740
18.05 kg

Power strip *



PWS1
500 / 430 / 569
1.1 kg



PWS2
500 / 430 / 569
1.6 kg

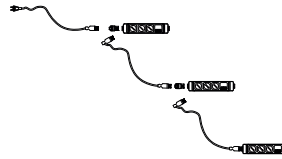

PWS3
500 / 430 / 569
2.1 kg

* dimensions expressed in millimeters: width x depth x height

Ogi W	Date of preparation 30.11.2021	The data contained in this document is valid in the day of its preparation. Change of the product, as long as it does not affect the basic features of it, does not require consistent updates of the document.	page 10/11
			products

Worktop



26 Aluminum satinato



31 Canadian oak *



39 Polar birch *

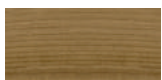

64 Cocoa *



168 Natural oak *

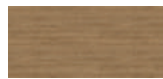

169 Honey oak*

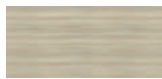

170 Acacia *



67 White pastel

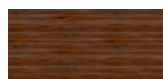

171 Dark walnut*

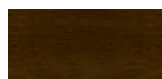

106 Lowland walnut *



154 Anthracite



08 Black



167 Grey oak *

Grommet



Aluminum



Beige



White



Black

Frame, mediabox - metal



M009 Aluminum semi-matt RAL9006



M015 White semi-matt RAL9010



M154 Antracite semi-matt RAL7043



M115 Black semi-matt RAL9005

Base



Natural ash

* body - II group

** OPTION WITH EXTRA CHARGE - worktop edge, colour: ash natural

*** the colour of desk legs may differ depending on natural wood ring pattern