

# Ogi U

## technical specification



.mdd

**.mdd has a leading position among manufacturers of office furniture with many awards that prove quality and continuously increase demand for it's products.**

The realities of today`s market require constant quality improvement at all levels of modern organization. This applies in particular to customer service, marketing, quality of products and also to quality of processes within the company.

Partnership relations among employees and with business partners form a base of economic growth and success of the company.

Constant investments in innovative machinery park, optimization of management systems and an expansion of production halls allow to minimize the lead times for the product of the highest quality.

**More than twenty years of experience in office furniture industry come with reference from a long list of companies and institutions to show their appreciation for an efficient and comprehensive service.**

**.mdd is higly aware of the environment.**

Being located in the forest region with lake by itis side, .mdd takes the nature seriously and invests constantly in a modern and energy-efficient solutions to preserve the local life. Company puts emphasis on waste segregation and recycling. .mdd has been awarded for the exceptional care and involvement in waste disposal. All materials used are environmentally friendly and enjoy a high 95 % rate of being recycled.



**General informations:**

**Warranty:**

.mdd products – **5 years.**

Electrical components and fabric – **2 years.**

**Certificate - MFC:**



**Compliant with standards:**

PN-EN 527-2:2017-02

**Boards density:**

12 mm - 690 - 750 kg/m<sup>3</sup>

18 mm - 650 - 690 kg/m<sup>3</sup>

28 mm - 610 - 630 kg/m<sup>3</sup>

36 mm - 610 - 630 kg/m<sup>3</sup>

**Assembly:**

product delivered in separate elements

**Packing:**

cardboard, perforated plastic mesh wrap

Ogi U	Date of preparation 30.11.2021	The data contained in this document is valid in the day of its preparation. Change of the product, as long as it does not affect the basic features of it, does not require consistent updates of the document.	page 2/13 <b>general informations</b>
-------	-----------------------------------	---	--

Ogi desk worktops

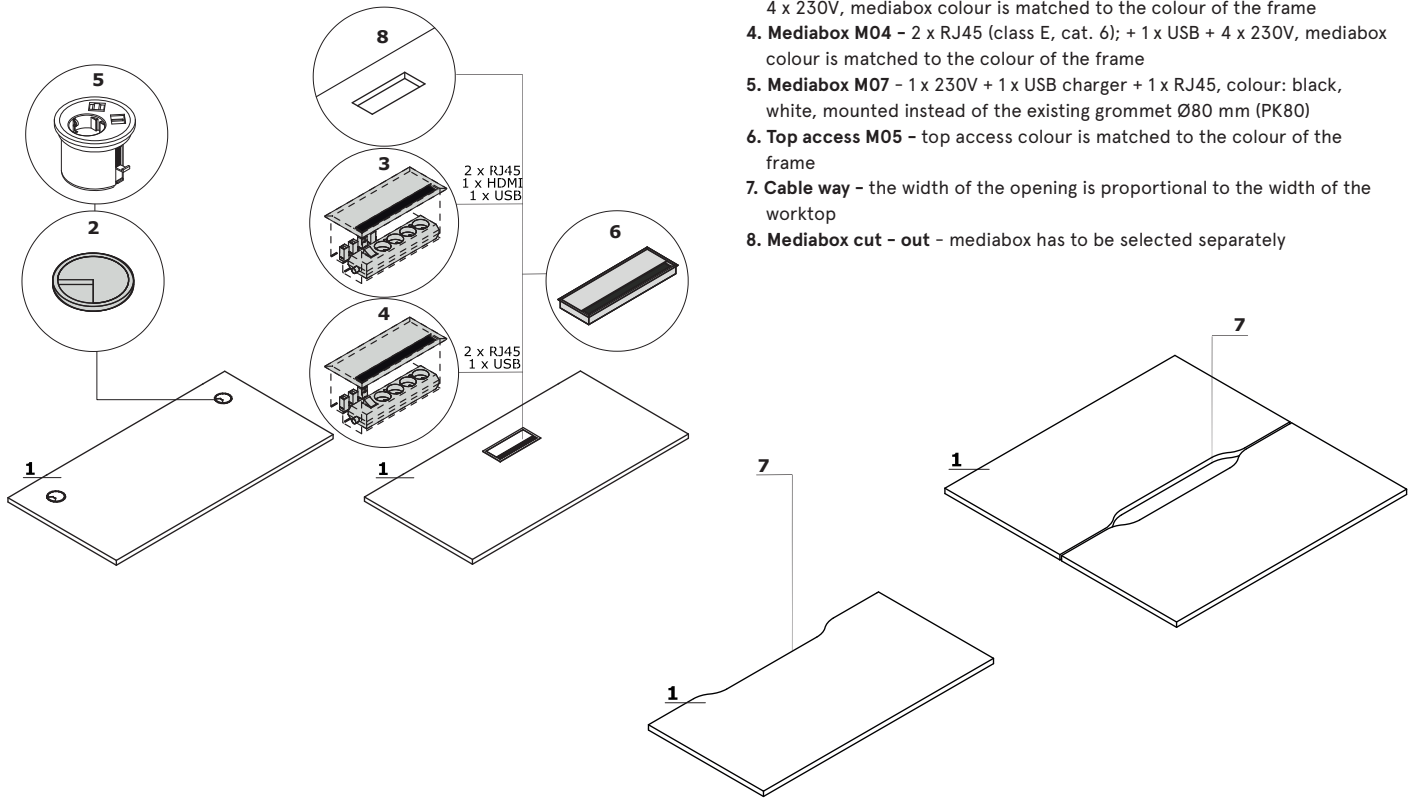

- 1. Worktop - MFC 28 mm, ABS edge
- OPTIONS WITH EXTRA CHARGE:**
- 2. Grommet - 2 pcs, Ø 80 mm
- 3. Mediabox M04H - 2 x RJ45 (class E, cat. 6); + 1 x USB + 1 x HDMI + 4 x 230V, mediabox colour is matched to the colour of the frame
- 4. Mediabox M04 - 2 x RJ45 (class E, cat. 6); + 1 x USB + 4 x 230V, mediabox colour is matched to the colour of the frame
- 5. Mediabox M07 - 1 x 230V + 1 x USB charger + 1 x RJ45, colour: black, white, mounted instead of the existing grommet Ø80 mm (PK80)
- 6. Top access M05 - top access colour is matched to the colour of the frame
- 7. Cable way - the width of the opening is proportional to the width of the worktop
- 8. Mediabox cut - out - mediabox has to be selected separately

Dimensions of radial worktops (mm)

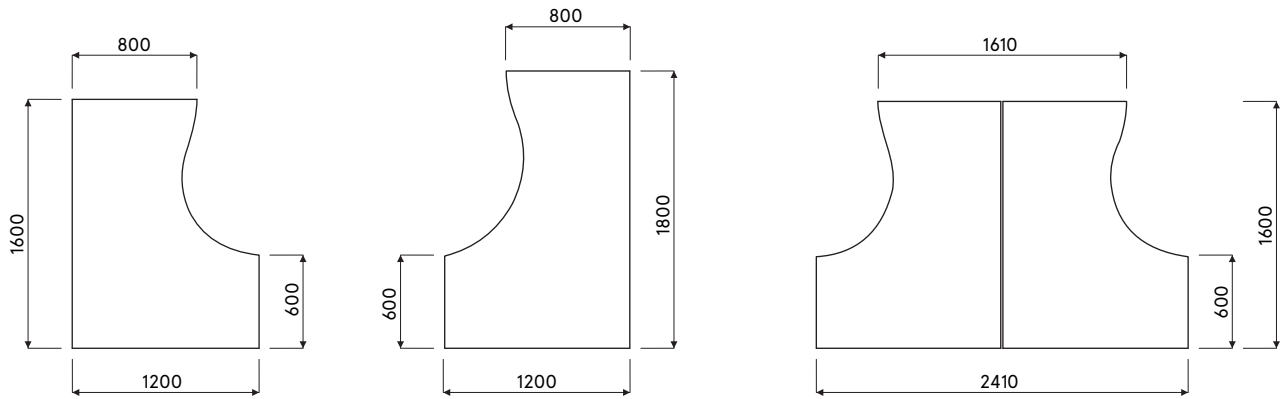

**Frame**

Ogi U: powder coated steel, profile 60x30 mm, spacer 10 mm between top and frame

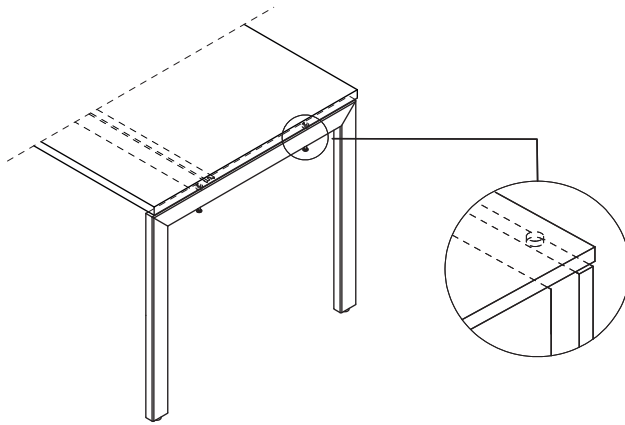

Attention - the cable tray located underneath the worktop is only available in: M009 - aluminium semi-matte colour

**Desk with managerial storage**

- 1. **Worktop** - MFC 28 mm, ABS edge
- 2. **Top** - MFC 28 mm, ABS edge
- 3. **Shelf** - MFC 18 mm, protection against accidental falling-out, ABS edge
- 4. **Drawer** - MFC 18 mm, ABS edge, patent lock - possible to change location
- 5. **Base** - MFC 18 mm, ABS edge
- 6. **Front** - MFC 18 mm, ABS edge

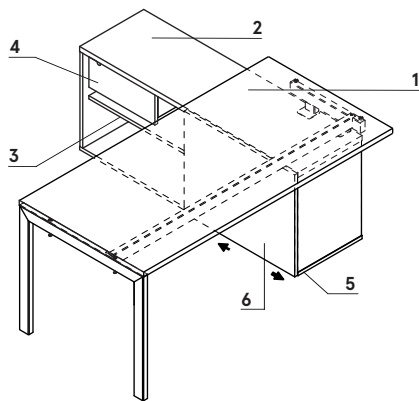

www.mdd.eu

**Configuration examples (mm)**

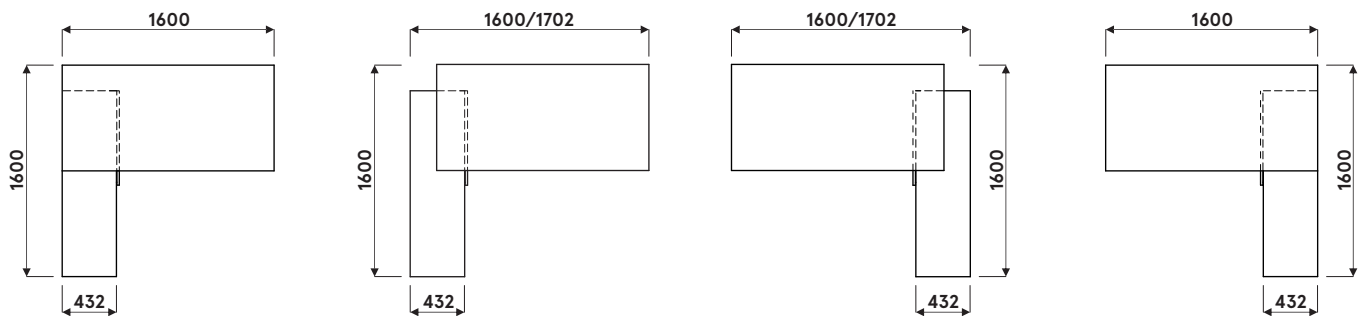

Configuration examples (mm)

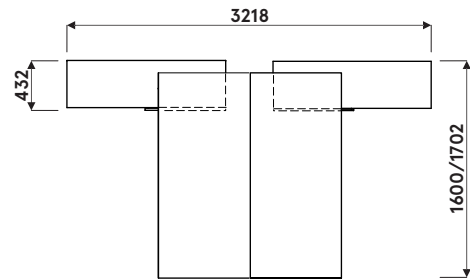
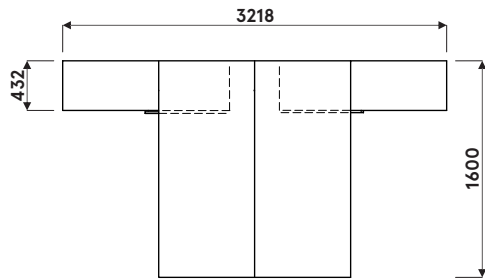

Configuration examples with BOX40, BOX50, BOX60

www.mdd.eu

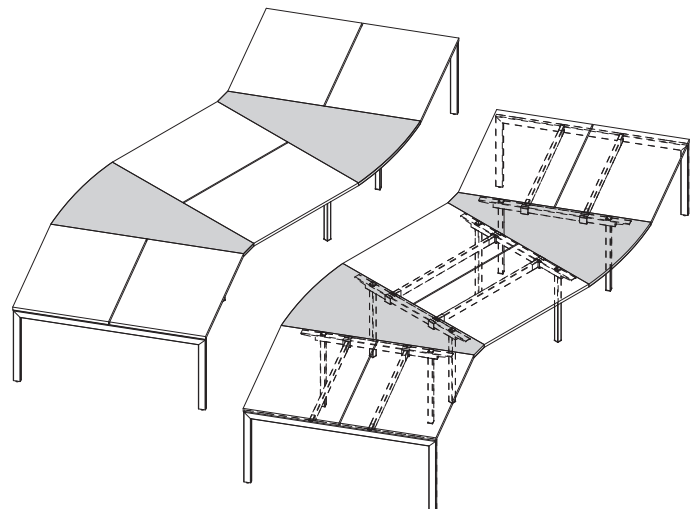
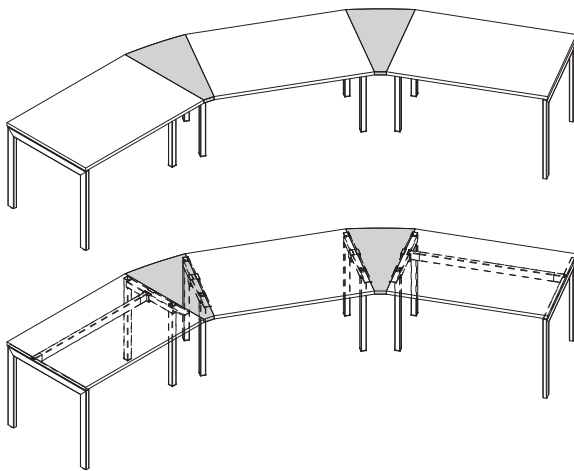

ATTENTION - only for Ogi Q, Ogi U, Ogi Y, Ogi M

Accessories

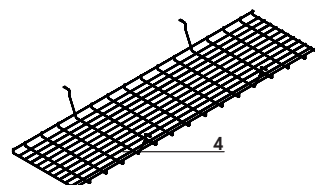
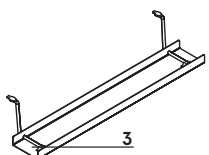
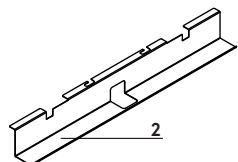
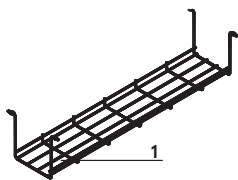

1. Horizontal cable tray S69 - powder coated, colour: 09 - aluminum
2. Single desk horizontal cable tray (SG12, SG16) - powder coated metal, colour: M009 - aluminum semi-matt
3. Horizontal cable tray E64 - powder coated, colour: M009 - aluminium semi-matt
4. Cable tray for bench desks (SG220, SG260) - steel wire Ø4 mm, powder coated, colour: 09 - aluminum

Ogi U	Date of preparation 30.11.2021	The data contained in this document is valid in the day of its preparation. Change of the product, as long as it does not affect the basic features of it, does not require consistent updates of the document.	page 5/13 technical description
-------	-----------------------------------	---	------------------------------------

Sliding top

1. Sliding top - shifting range 141 mm

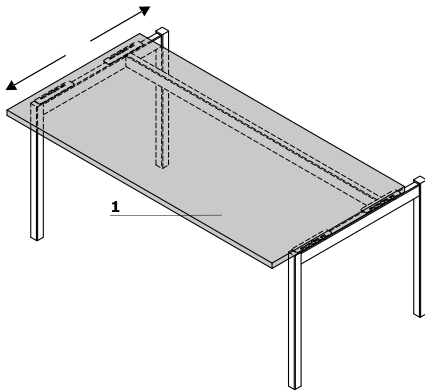

Note - M04, M04H, and M07 mediaboxes cannot be installed.

Power strip - for series connection

- 1. **PWS1** - set for 1 workstation - power strip (3x SCHUCKO, 2x RJ45) x1 + power cord (universal outlet PL/FR/Schucko)
- 2. **PWS2** - set for 2 workstation - power strip (3x SCHUCKO, 2x RJ45) x2 + set of power cords (universal outlet PL/FR/Schucko)
- 3. **PWS3** - set for 3 workstation - power strip (3x SCHUCKO, 2x RJ45) x3 + set of power cords (universal outlet PL/FR/Schucko)

1

2

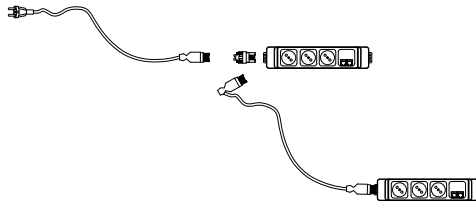
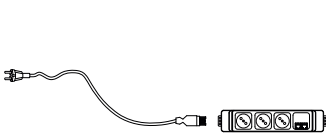

3

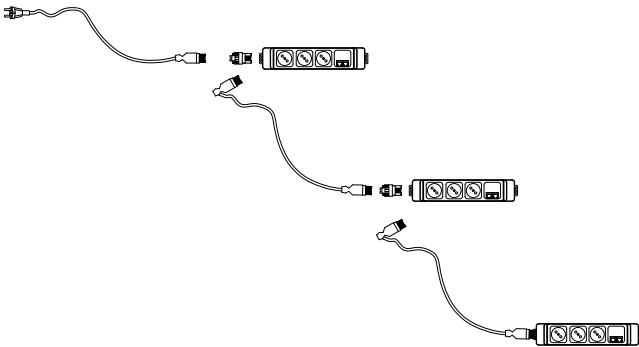

Desks \*

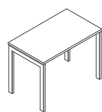

**BOU10**  
1000 / 600 / 740  
26.7 kg



**BOU12**  
1200 / 600 / 740  
30.4 kg



**BOU14**  
1400 / 600 / 740  
32.9 kg

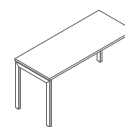

**BOU16**  
1600 / 600 / 740  
36.2 kg

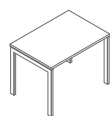

**BOU49**  
1000 / 700 / 740  
26.7 kg

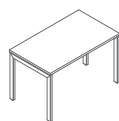

**BOU28**  
1200 / 700 / 740  
34.4 kg

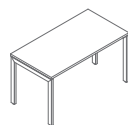

**BOU29**  
1400 / 700 / 740  
61 kg

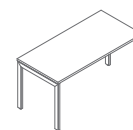

**BOU30**  
1600 / 700 / 740  
61.55 kg

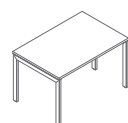

**BOU19**  
1200 / 800 / 740  
37 kg

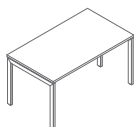

**BOU20**  
1400 / 800 / 740  
39.5 kg



**BOU21**  
1600 / 800 / 740  
44.55 kg

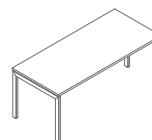

**BOU22**  
1800 / 800 / 740  
48.55 kg

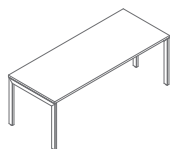

**BOU27**  
2000 / 800 / 740  
49.35 kg

\* dimensions expressed in millimeters: width x depth x height

Elements for arrangement building - straight desk \*

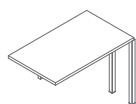

**BOX10**  
1000 / 600 / 740  
20.7 kg

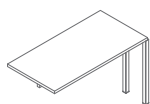

**BOX12**  
1200 / 600 / 740  
22.7 kg

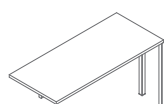

**BOX14**  
1400 / 600 / 740  
25.4 kg

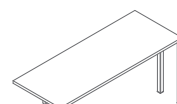

**BOX16**  
1600 / 600 / 740  
28.9 kg

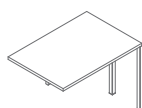

**BOX30**  
1000 / 700 / 740  
20.7 kg

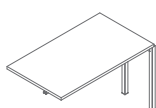

**BOX32**  
1200 / 700 / 740  
28.4 kg

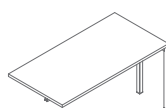

**BOX34**  
1400 / 700 / 740  
30 kg

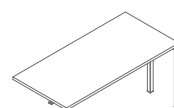

**BOX36**  
1600 / 700 / 740  
33.55 kg



**BOX40**  
500 / 800 / 740  
11 kg

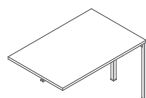

**BOX42**  
1200 / 800 / 740  
30.8 kg

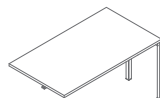

**BOX43**  
1400 / 800 / 740  
33.3 kg

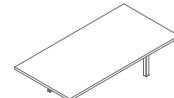

**BOX44**  
1600 / 800 / 740  
38.35 kg

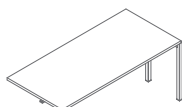

**BOX45**  
1800 / 800 / 740  
42.35 kg

\* dimensions expressed in millimeters: width x depth x height



Radial desks \*

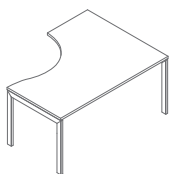

**BOU23**  
1600 / 1200 / 740  
48.35 kg

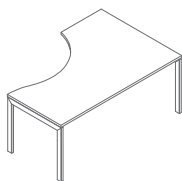

**BOU25**  
1800 / 1200 / 740  
51.2 kg

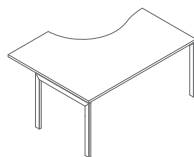

**BOU24**  
1600 / 1200 / 740  
47.65 kg

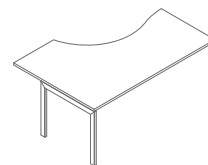

**BOU26**  
1800 / 1200 / 740  
50.85 kg

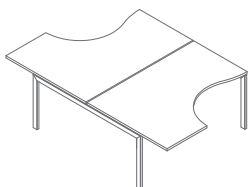

**BOU15**  
1600 / 2410 / 740  
89.3 kg

Desks with managerial storage \*

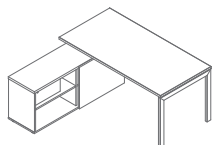

**BOUL20**  
1600-1702 / 1600 / 740  
103.15 kg

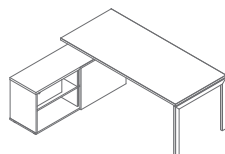

**BOUL21**  
1800-1902 / 1600 / 740  
107.15 kg

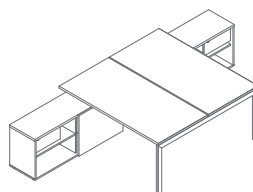

**BOUL40**  
1600-1702 / 3210 / 740  
203.1 kg

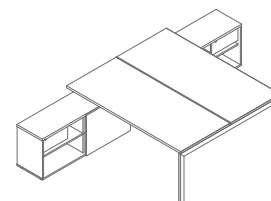

**BOUL41**  
1800-1902 / 3210 / 740  
211.1 kg

\* dimensions expressed in millimeters: width x depth x height

**Bench desks \***

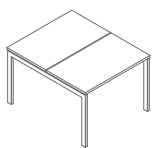

**BOU50**  
1000 / 1210 / 740  
44.6 kg

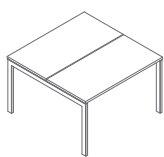

**BOU52**  
1200 / 1210 / 740  
48.6 kg

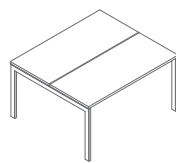

**BOU54**  
1400 / 1210 / 740  
54 kg

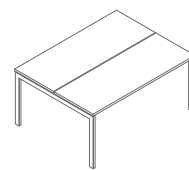

**BOU56**  
1600 / 1210 / 740  
61 kg

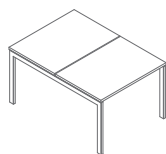

**BOU48**  
1000 / 1410 / 740  
45.9 kg

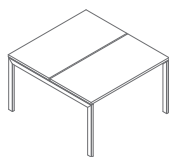

**BOU42**  
1200 / 1410 / 740  
61.3 kg

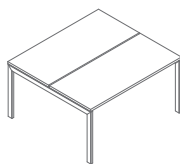

**BOU44**  
1400 / 1410 / 740  
64.5 kg

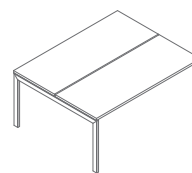

**BOU46**  
1600 / 1410 / 740  
71.6 kg

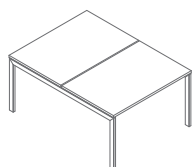

**BOU32**  
1200 / 1610 / 740  
67.3 kg

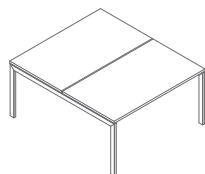

**BOU33**  
1400 / 1610 / 740  
72.3 kg

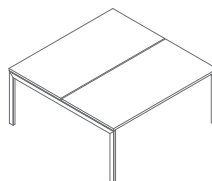

**BOU34**  
1600 / 1610 / 740  
82.4 kg

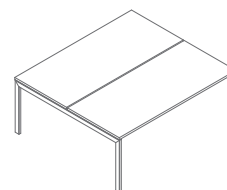

**BOU35**  
1800 / 1610 / 740  
90.4 kg

www.mdd.pl

**Elements for arrangement building - bench \***

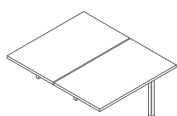

**BOX20**  
1000 / 1210 / 740  
36.6 kg

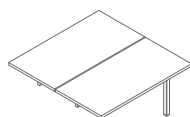

**BOX22**  
1200 / 1210 / 740  
40.6 kg

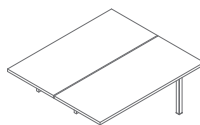

**BOX24**  
1400 / 1210 / 740  
46 kg

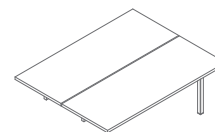

**BOX26**  
1600 / 1210 / 740  
53 kg

\* dimensions expressed in millimeters: width x depth x height

Elements for arrangement building - bench \*



**BOX50**  
1000 / 1410 / 740  
24.05 kg

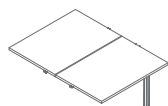

**BOX51**  
1000 / 1410 / 740  
38.2 kg

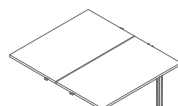

**BOX52**  
1200 / 1410 / 740  
53.6 kg

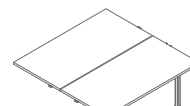

**BOX54**  
1400 / 1410 / 740  
56.8 kg

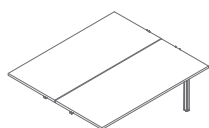

**BOX56**  
1600 / 1410 / 740  
63.9 kg

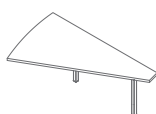

**BOX60**  
1000 / 1610 / 740  
28.75 kg

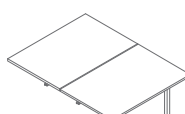

**BOX62**  
1200 / 1610 / 740  
58.35 kg

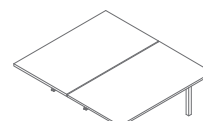

**BOX64**  
1400 / 1610 / 740  
63.35 kg

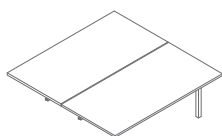

**BOX66**  
1600 / 1610 / 740  
73.45 kg

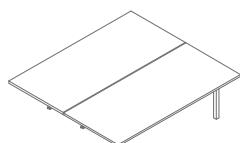

**BOX68**  
1800 / 1610 / 740  
81.45 kg

Desk extenstions \*

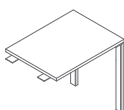

**PLU01**  
600 / 800 / 740  
17.8 kg

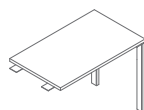

**PLU02**  
600 / 1000 / 740  
19.8 kg

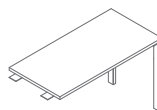

**PLU03**  
600 / 1200 / 740  
22 kg

\* dimensions expressed in millimeters: width x depth x height

Power strip \*



**PWS1**  
500 / 430 / 569  
1.1 kg



**PWS2**  
500 / 430 / 569  
1.6 kg

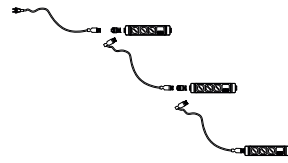

**PWS3**  
500 / 430 / 569  
2.1 kg

\* dimensions expressed in millimeters: width x depth x height

<b>Ogi U</b>	Date of preparation 30.11.2021	The data contained in this document is valid in the day of its preparation. Change of the product, as long as it does not affect the basic features of it, does not require consistent updates of the document.	page 12/13
			<b>products</b>

**Worktop**



26 Aluminum satinato



31 Canadian oak \*



39 Polar birch \*



64 Cocoa \*



168 Natural oak \*

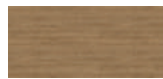

169 Honey oak\*

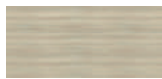

170 Acacia \*



67 White pastel

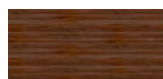

171 Dark walnut\*

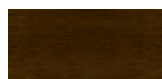

106 Lowland walnut \*



154 Anthracite



08 Black



167 Grey oak \*

**Grommet**



Aluminum



Beige



White



Black

**Frame, mediabox - metal**



M009 Aluminum semi-matt RAL9006



M015 White semi-matt RAL9010



M154 Antracite semi-matt RAL7043



M115 Black semi-matt RAL9005

\* body - II group