

Colour combination - Status

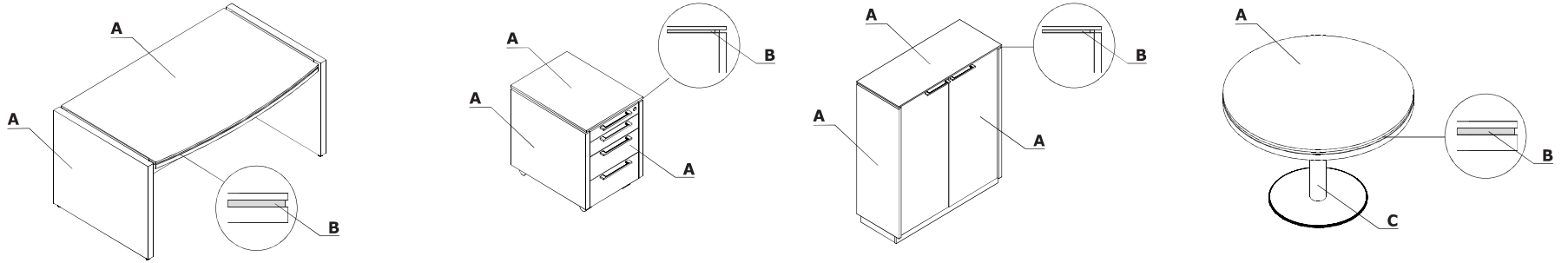

Material	Colour	All elements		Tables - disc base											
		A - MFC elements	B - Spacer	C - Column											
MFC	31 - canadian oak	✓													
	34 - chestnut	✓													
	106 - lowland walnut	✓													
	154 - anthracite		✓												
Metal	M009 - aluminium semi-matt RAL 9006			✓											
	M015 - white semi-matt RAL 9010			✓											
	M115 - black semi-matt RAL 9005			✓											

Desks

- Worktop** - MFC 52 mm (12+12+28 mm), ABS edge
- Base** - MFC 52 mm, ABS edge
- Modesty panel** - MFC 18 mm, ABS edge
- Thickening element** - MFC 12 mm, colour: 154 - anthracite
- Leveling** - 10 mm range

Possible mediaport location

- **Mediaport S91E** - location A, B (1pc);
- **Mediaport S91E** - 2x 230V, 2x RJ45

Desk extensions

- Worktop** - MFC 52 mm (12+12+28 mm), ABS edge
- Base** - MFC 52 mm, ABS edge
- Modesty panel** - MFC 18 mm, ABS edge
- Thickening element** - MFC 12 mm, colour: 154 - anthracite
- Leveling** - 5 mm range
- Base** - MFC 61x61 mm, ABS edge

X15 / X16

X14

ATTENTION - X14 front extension, X15 right extension, X16 left extensio

MFC base meeting tables

- 1 **Worktop** - MFC 52 mm (12+12+28 mm), ABS edge
- 2 **Base** - MFC 52 mm, ABS edge
- 3 **Modesty panel** - MFC 18 mm, ABS edge
- 4 **Thickening element** - MFC 12 mm, colour: 154 - anthracite
- 5 **Leveling** - 5 mm range

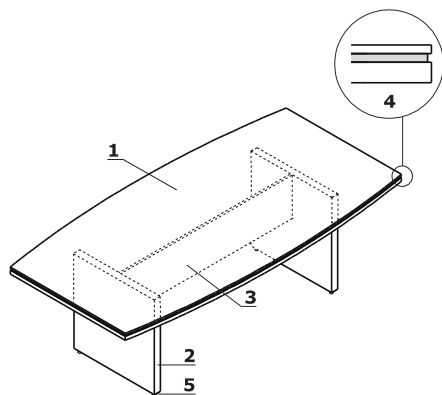

Disc base meeting tables

- 1 **Worktop** - MFC 52 mm (12+12+28 mm), ABS edge
- 2 **Column** - powder coated steel
- 3 **Disc** - stainless steel
- 4 **Thickening element** - MFC 12 mm, colour: 154 - anthracite

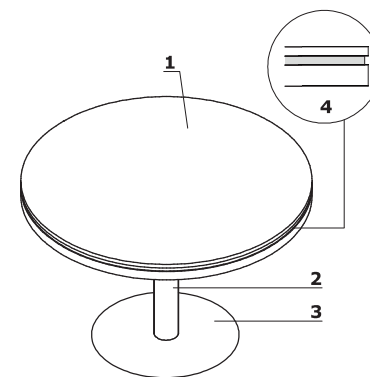

Mobile pedestals

- 1 **Top** - MFC 12 mm, ABS edge
- 2 **Side panels** - MFC 28 mm, ABS edge
- 3 **Separate pencil drawer**
- 4 **Castors** - Ø50 mm, two with brakes
- 5 **Central lock** - foldable key
- 6 **Front** - MFC 18 mm, ABS edge
- 7 **Aluminum handle**
- 8 **Thickening element** - colour: M154 - anthracite semi-matt
- 9 **Suspension files drawer** - ball runners, max load 30 kg, 100% extraction

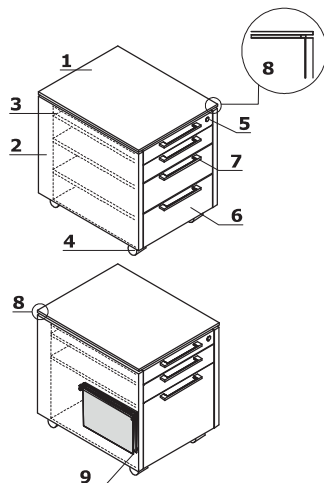

Storages

- 1 **Top** - MFC 12 mm, ABS edge
- 2 **Side panels** - MFC 28 mm, ABS edge
- 3 **Base** - MFC 18 mm, ABS edge
- 4 **Glass front** - transparent tempered glass 5 mm
- 5 **Front** - MFC 18 mm, ABS edge, plain hinge 110°
- 6 **Body** - MFC 18 mm, colour: 154 - anthracite
- 7 **Aluminum handle**
- 8 **Thickening element** - colour: M154 - anthracite semi-matt

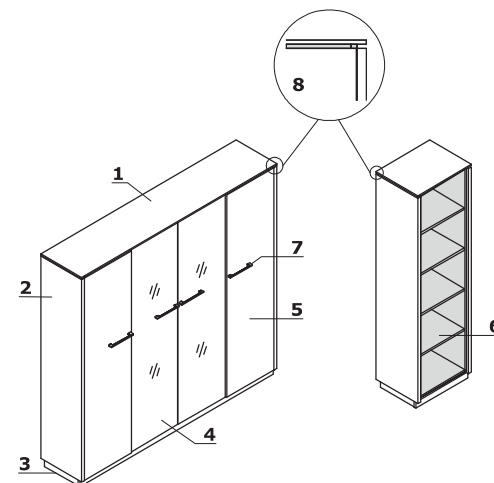



ATTENTION - Storages without lock; Possibility of adding espagnolette lock only for MFC doors - extra charge (40EUR);. Each door (L/R); needs separate lock. To order add letter "Z" at the end of product index.

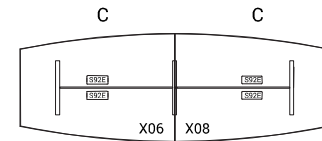
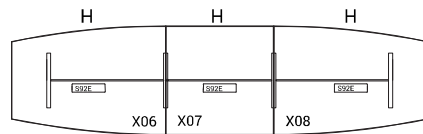
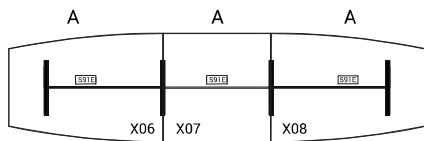
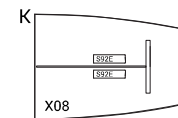
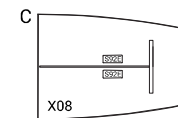
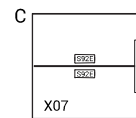
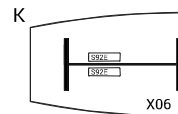
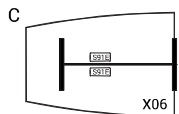
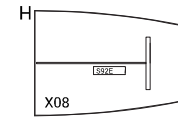
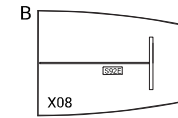
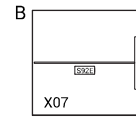
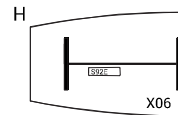
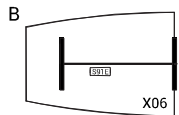
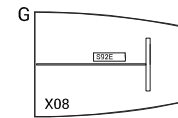
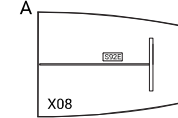
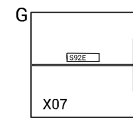
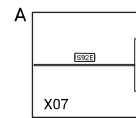
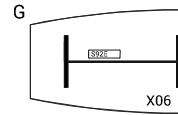
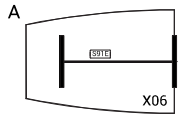
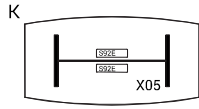
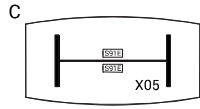
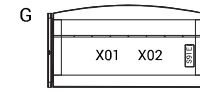
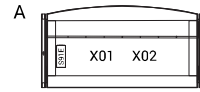
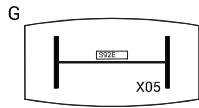
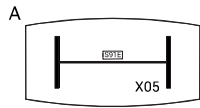

Possible mediaport location

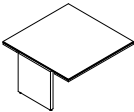
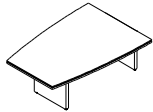
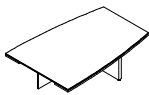

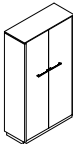
TO ORDER PRODUCT WITH MEDIABOX, AT THE END OF THE SYMBOL SHOULD BE ADDED A LETTER (A,B...); WHICH IS CORRESPONDING TO THE SELECTED CONFIGURATION (EX. X01A);

Meeting tables							
	Symbol	Price EUR	Dimensions			kg m3 pcs	Comments
			Width	Depth	Height		
	X07	525,-	1400	1400	760	89.6 kg 0.182 m3 2 pcs	middle element of conference table, media port location A, B,G,H (1 pcs); or C,K (2pcs);
	X06	821,-	2000	1000 1400	760	113.7 kg 0,277 m3 2 pcs	begining element for conference table, media port location A,B,G,H (1 pcs); or C,K (2pcs);
	X08	745,-	2000	1000 1400	760	100.1 kg 0,246 m3 2 pcs	end element of conference table, media port location A,B,G,H (1 pcs); or C,K (2pcs);
Storages							
	X26	337,-	544	421	820	44.2 kg 0,115 m3 3 pcs	left door, 20H
	X27	337,-	544	421	820	44.2 kg 0,115 m3 3 pcs	right door, 20H
	X36	388,-	544	421	1167	60.2 kg 0,131 m3 3 pcs	left door, 30H
	X37	388,-	544	421	1167	60.2 kg 0,131 m3 3 pcs	right door, 30H
	X56	495,-	544	421	1871	89.8 kg 0,208 m3 3 pcs	left door, 50H
	X57	495,-	544	421	1871	89.8 kg 0,208 m3 3 pcs	right door, 50H
	X21	444,-	1032	421	820	68.051 kg 0,161 m3 3 pcs	20H
	X31	515,-	1032	421	1167	92.751 kg 0,209 m3 3 pcs	30H
	X51	704,-	1032	421	1871	138.251 kg 0,312 m3 4 pcs	50H

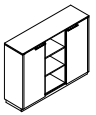
Extra charge							

Half bookcases							
	Symbol	Price EUR	Dimensions			kg m3 pcs	Comments
			Width	Depth	Height		
	X3679	801,-	1520	421	1167	132.7 kg 0,285 m3 5 pcs	30H
	X5679	1051,-	1520	421	1871	195.9 kg 0,445 m3 5 pcs	50H
	X3119	1102,-	2496	421	1167	199.6 kg 0,453 m3 5 pcs	30H
	X5119	1438,-	2496	421	1871	294.6 kg 0,663 m3 7 pcs	50H
	X5129	1403,-	2496	421	1871	284.3 kg 0,645 m3 7 pcs	wardrobe part with slide out hanger, 50H
	Accessories						
	S91E	330,-	267	110	93	1 kg 0,01 m3 1 pcs	mediaport 2 x 230V, 2 x RJ45
	S92E	500,-	426	110	93	1 kg 0,014 m3 1 pcs	mediaport 4 x 230V, 4 x RJ45

Extra charge							