

Viga M

technical specification



.mdd

.mdd has a leading position among manufacturers of office furniture with many awards that prove quality and continuously increase demand for its products.

The realities of today's market require constant quality improvement at all levels of modern organization. This applies in particular to customer service, marketing, quality of products and also to quality of processes within the company. Partnership relations among employees and with business partners form a base of economic growth and success of the company.

Constant investments in innovative machinery park, optimization of management systems and an expansion of production halls allow to minimize the lead times for the product of the highest quality.

More than twenty years of experience in office furniture industry come with reference from a long list of companies and institutions to show their appreciation for an efficient and comprehensive service.

.mdd is highly aware of the environment.

Being located in the forest region with lake by its side, .mdd takes the nature seriously and invests constantly in a modern and energy-efficient solutions to preserve the local life. Company puts emphasis on waste segregation and recycling. .mdd has been awarded for the exceptional care and involvement in waste disposal. All materials used are environmentally friendly and enjoy a high 95 % rate of being recycled.



General informations:

Warranty:

.mdd products - **5 years**.
Electrical components and fabric - **2 years**.

Certificate - MFC:



Assembly:

product delivered in separate elements

Packing:

cardboard, foam wrap,
honeycomb texture

Compliant with standards:

PN-EN 527-2:2017-02
PN-EN 14073-2:2006

Material composition *:

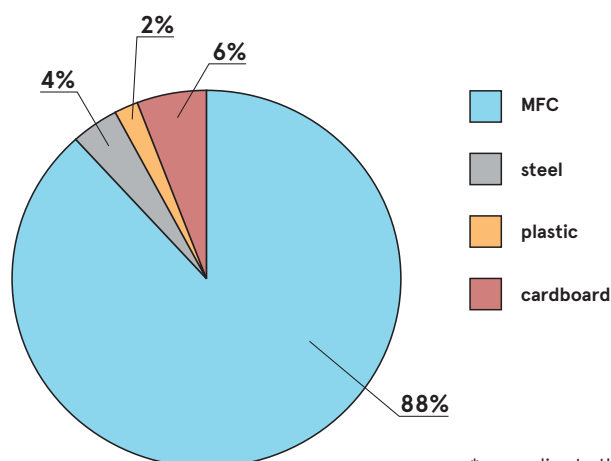

* according to the EPD document

Recyclability **

Recyclable: 10% - Downcyclable: 90%

Recycled content

4%

Co2 carbon footprint

112,5 kg

** average values for a representative of the group; values may vary for other products

Desks - worktop

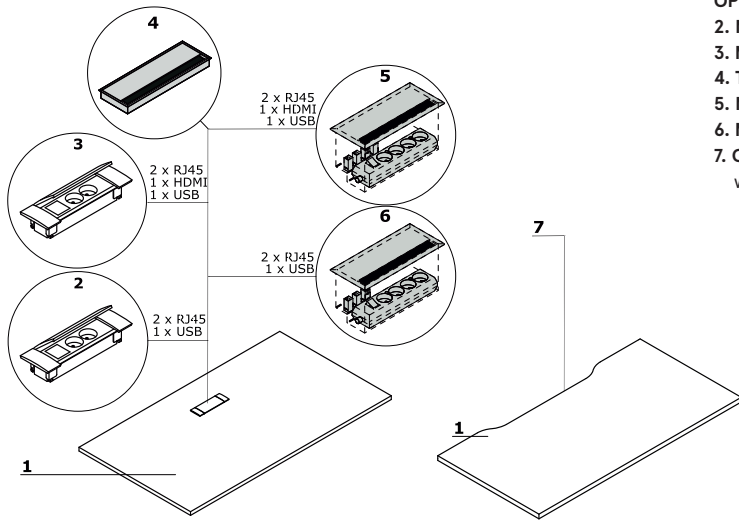

1. Top - MFC 18 mm, ABS edge

OPTIONS WITH EXTRA CHARGE:

- 2. Mediabox M06 - 2x230V+USB charger, colour: black
- 3. Mediabox M06H - 2x230V+HDMI+USB, colour: black
- 4. Top access M05
- 5. Mediabox M04H - 2xRJ45 (class E, cat. 6); + 1 x USB + 1 x HDMI + 4 x 230V
- 6. Mediabox M04 - 2xRJ45 (class E, cat. 6); + 1 x USB + 4 x 230V
- 7. Cable way - the width of the opening is proportional to the width of the worktop

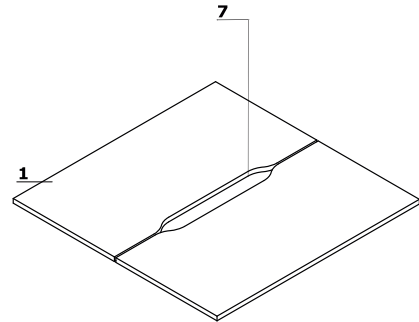

Frame

- 1. Leg - natural wood - oak, profile 80x40mm
- 2. Frame - anodised aluminium, colour: black; spacer 30 mm between top and frame

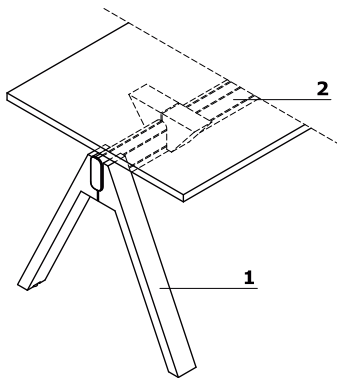

Extensions - for bench desks

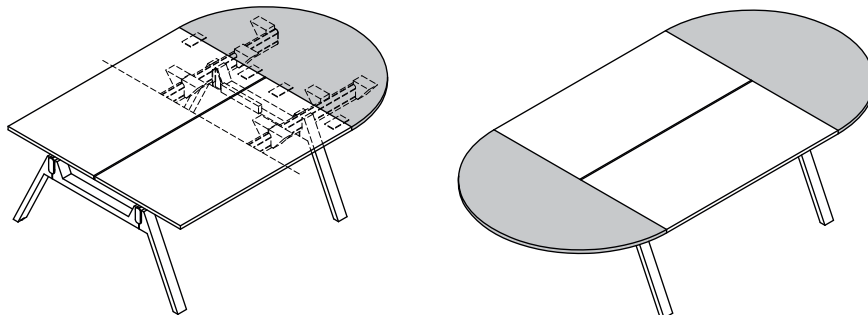

option with extra charge

<p>Viga M</p>	<p>Date of preparation 30.05.2023</p>	<p>The data contained in this document is valid in the day of its preparation. Change of the product, as long as it does not affect the basic features of it, does not require consistent updates of the document.</p>	<p>page 3/20 technical description</p>
----------------------	---	--	---

Desks with managerial storage

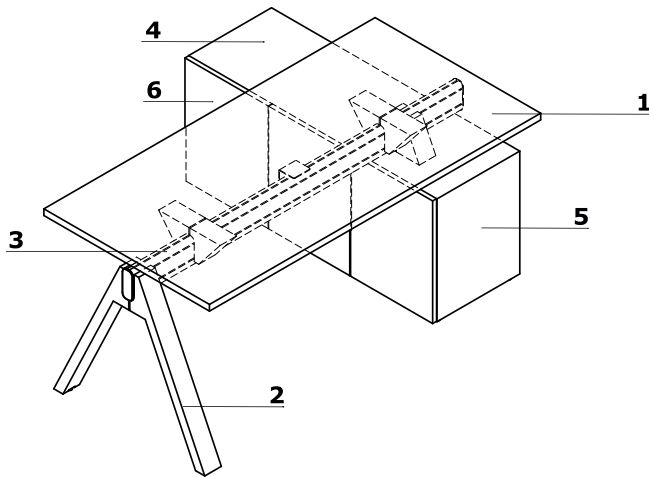

1. **Top** - MFC 18 mm, ABS edge
2. **Leg** - natural wood - oak, profile 80x40mm
3. **Frame** - anodised aluminium, colour: black; spacer 30 mm between top and frame
4. **Top** - MFC 18 mm, ABS edge
5. **Body** - MFC 18 mm, ABS edge
6. **Front** - Push-to-Open, MFC 18 mm, ABS edge

Viga M	Date of preparation 30.05.2023	The data contained in this document is valid in the day of its preparation. Change of the product, as long as it does not affect the basic features of it, does not require consistent updates of the document.	page 4/20 technical description
---------------	-----------------------------------	---	---

Desk with managerial cabinet - worktop

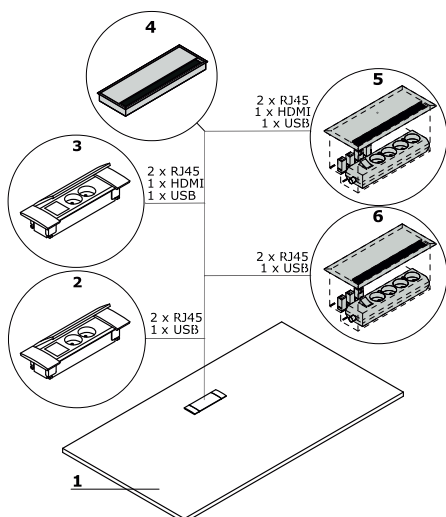

1. Worktop - MFC 28 mm, ABS edge

OPTIONS WITH EXTRA CHARGE:

2. Mediabox M06 - 2x230V+USB charger, colour: black

3. Mediabox M06H - 2x230V+HDMI+USB, colour: black

4. Top access M05

5. Mediabox M04H - 2xRJ45 (class E, cat. 6); + 1 x USB + 1 x HDMI + 4 x 230V

6. Mediabox M04 - 2xRJ45 (class E, cat. 6); + 1 x USB + 4 x 230V

Frame

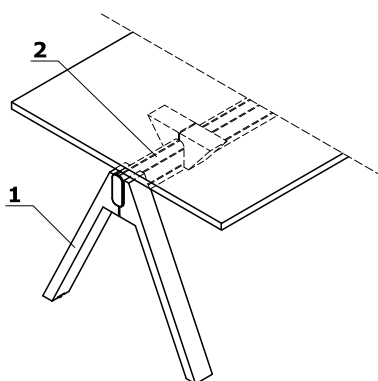

1. Leg - natural wood - oak, profile 80x40mm

2. Frame - anodised aluminium, colour: black; spacer 30 mm between top and frame

Storages

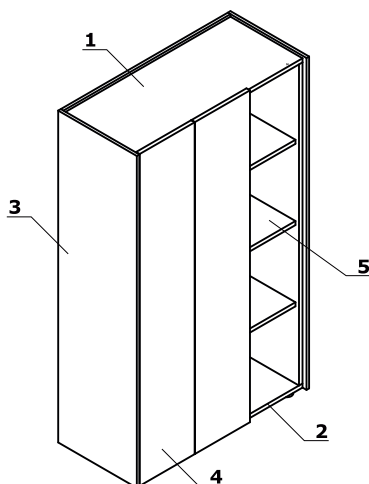

1. Top - MFC 18 mm, ABS edge

2. Base - MFC 18 mm, ABS edge

3. Body outside - MFC 12 mm

4. Front - Push-to-Open, MFC 18 mm, ABS edge

5. Shelf - MFC 18 mm, protection against accidental falling-out, ABS edge

Desks with managerial storage

1. **Worktop** - MFC 28 mm, ABS edge
2. **Modesty panel** - MFC 12 mm; handle - powder coated steel, colour: black

PEDESTAL:

3. **Top** - MFC 18 mm, ABS edge
4. **Base** - MFC 18 mm, ABS edge
5. **Body outside** - MFC 12 mm
6. **Body inside** - MFC 18 mm
7. **Front** - MFC 12 mm
8. **MFC drawer** - ball runners, max load 25kg, 100% extraction; soft closing
9. **Shelf** - MFC 18 mm, protection against accidental falling-out, ABS edge

MANAGERIAL STORAGE:

10. **Top** - MFC 18 mm, ABS edge
11. **Base** - MFC 18 mm, ABS edge
12. **Body outside** - MFC 12 mm
13. **Body inside** - MFC 18 mm
14. **Sliding front** - MFC 18 +12 mm, soft-closing system
15. **MFC drawer** - ball runners, 100% extraction; soft closing
16. **Patent lock**

DESK WITH MANAGERIAL CABINET (CABINET WITH ACCESS FROM BOTH SIDES):

17. **Top** - MFC 18 mm, ABS edge
18. **Base** - MFC 18 mm, ABS edge
19. **Body outside** - MFC 12 mm
20. **Body inside** - MFC 18 mm
21. **Sliding front** - MFC 18 +12 mm, soft-closing system
22. **MFC drawer** - ball runners, 100% extraction; soft closing
23. **Patent lock**

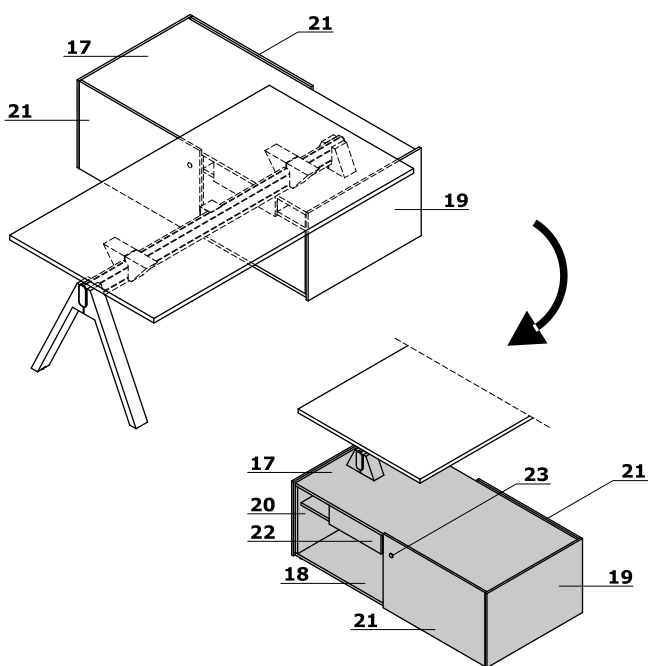
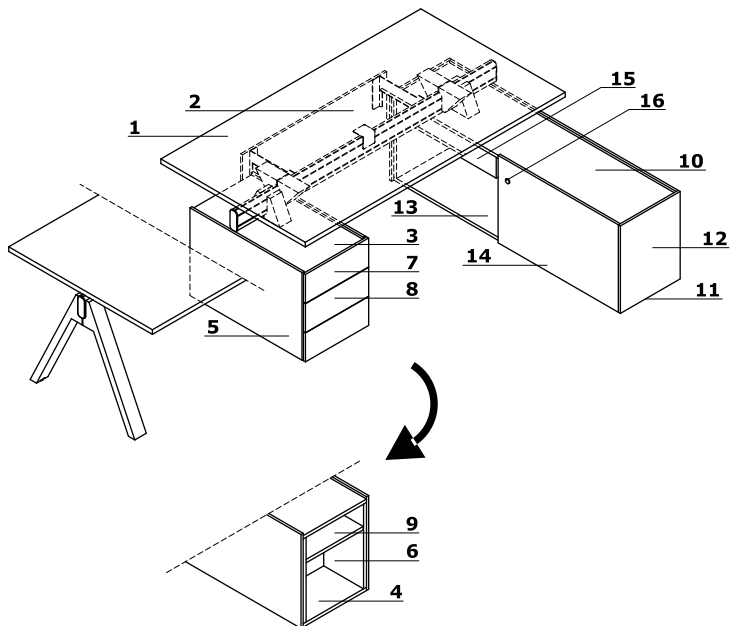

Pedestals

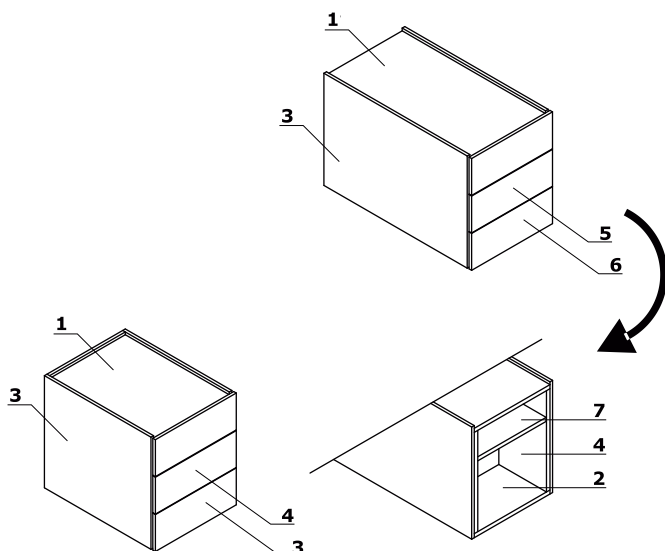

1. Top - MFC 18 mm, ABS edge
2. Base - MFC 18 mm, ABS edge
3. Body outside - MFC 12 mm
4. Body inside - MFC 18 mm
5. Front - MFC 12 mm
6. MFC drawer - ball runners, 100% extraction; soft closing
7. Shelf - MFC 18 mm, protection against accidental falling-out, ABS edge

Conference tables

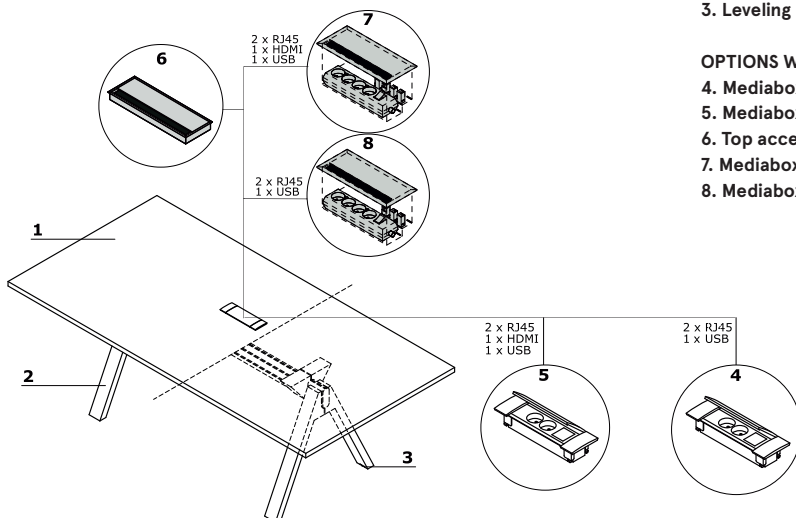

1. Top - MFC 18 mm, ABS edge
2. Leg - natural wood - oak, profile 80x40mm
3. Leveling - 5 mm range

OPTIONS WITH EXTRA CHARGE:

4. Mediabox M06 - 2x230V+USB charger, colour: black
5. Mediabox M06H - 2x230V+HDMI+USB, colour: black
6. Top access M05
7. Mediabox M04H - 2xRJ45 (class E, cat. 6); + 1 x USB + 1 x HDMI + 4 x 230V
8. Mediabox M04 - 2xRJ45 (class E, cat. 6); + 1 x USB + 4 x 230V

Mediabox location

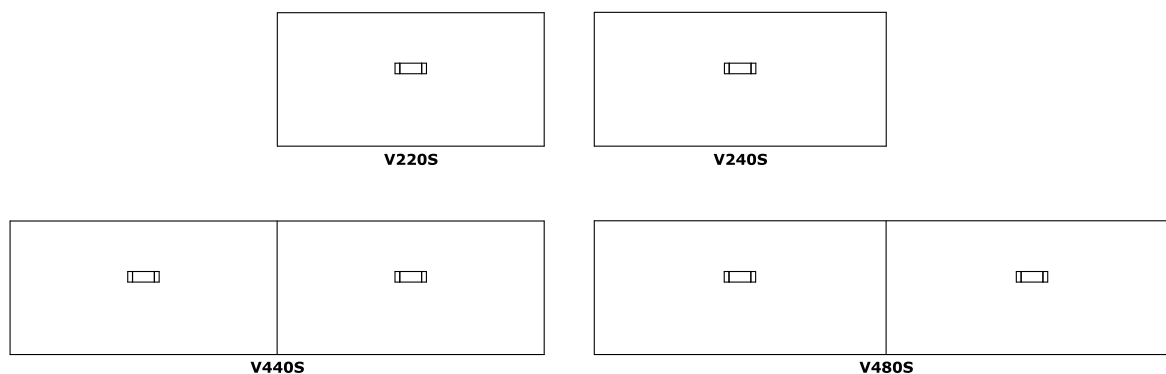

High tables

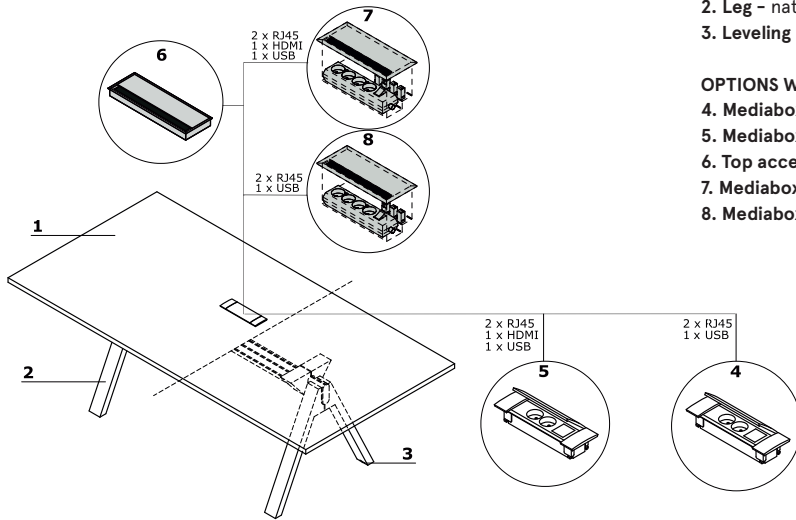

- 1. Top - MFC 18 mm, ABS edge
- 2. Leg - natural wood - oak, profile 80x40mm
- 3. Leveling - 5 mm range

OPTIONS WITH EXTRA CHARGE:

- 4. Mediabox M06 - 2x230V+USB charger, colour: black
- 5. Mediabox M06H - 2x230V+HDMI+USB, colour: black
- 6. Top access M05
- 7. Mediabox M04H - 2xRJ45 (class E, cat. 6); + 1 x USB + 1 x HDMI + 4 x 230V
- 8. Mediabox M04 - 2xRJ45 (class E, cat. 6); + 1 x USB + 4 x 230V

Desks *



V16M
1600 / 800 / 740
44.86 kg

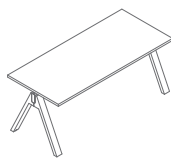

V18M
1800 / 800 / 740
48.79 kg

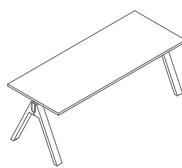

V20M
2000 / 800 / 740
52.72 kg

Bench desks *

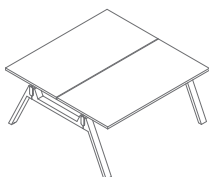

V216M
1600 / 1610 / 740
93.72 kg

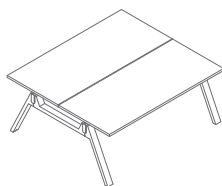

V218M
1800 / 1610 / 740
101.58 kg

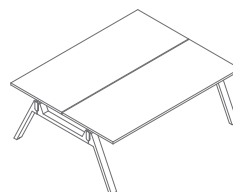

V220M
2000 / 1610 / 740
109.44 kg

Extension units - straight desk *

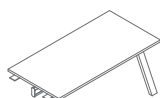

V16LM
1600 / 800 / 740
41.16 kg

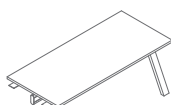

V18LM
1800 / 800 / 740
45.091 kg

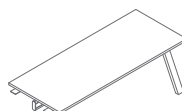

V20LM
2000 / 800 / 740
82.02 kg

Extension units - bench *

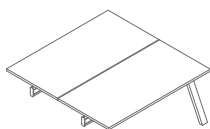

V216LM
1600 / 1610 / 740
87.72 kg

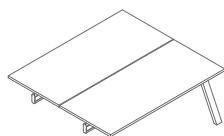

V218LM
1800 / 1610 / 740
95.58 kg

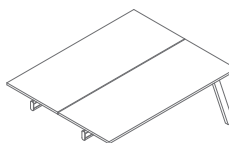

V220LM
2000 / 1610 / 740
103.44 kg

* dimensions expressed in millimeters: width x depth x height

Desk with managerial cabinet *

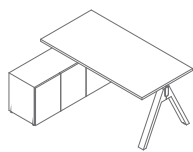

V163LM
1600 / 1300 / 740
85.36 kg

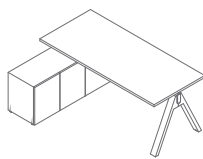

V183LM
1800 / 1300 / 740
89.29 kg

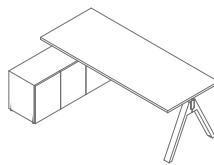

V203LM
2000 / 1300 / 740
93.22 kg

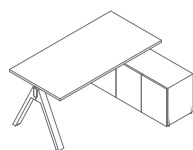

V163PM
1600 / 1300 / 740
85.36 kg

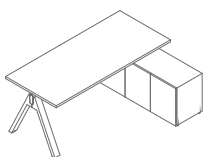

V183PM
1800 / 1300 / 740
89.29 kg

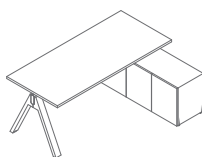

V203PM
2000 / 1300 / 740
93.22 kg

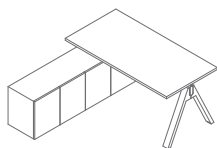

V164LM
1600 / 1700 / 740
96.36 kg

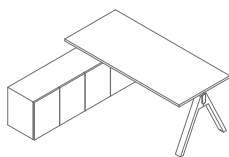

V184LM
1800 / 1700 / 740
100.29 kg

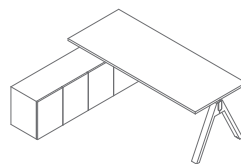

V204LM
2000 / 1700 / 740
104.22 kg

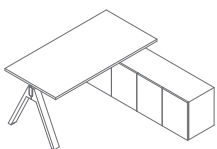

V164PM
1600 / 1700 / 740
96.36 kg

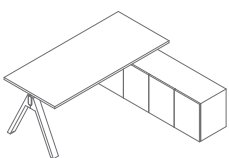

V184PM
1800 / 1700 / 740
100.29 kg

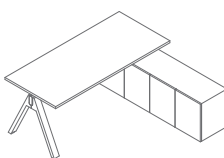

V204PM
2000 / 1700 / 740
104.22 kg

* dimensions expressed in millimeters: width x depth x height

Desk with managerial cabinet *

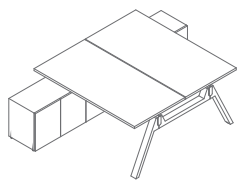

V1623M
1600 / 2400 / 740
178.72 kg

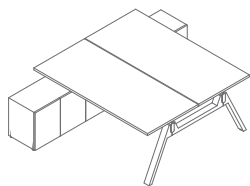

V1823M
1800 / 2400 / 740
186.58 kg

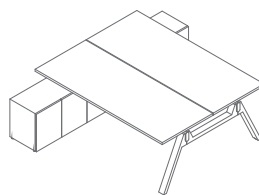

V2023M
2000 / 2400 / 740
194.44 kg

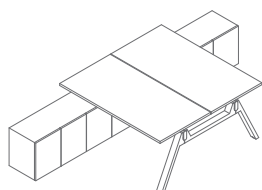

V1624M
1600 / 3200 / 740
200.72 kg

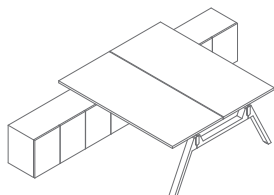

V1824M
1800 / 3200 / 740
208.58 kg

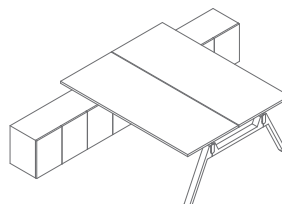

V2024M
2000 / 3200 / 740
216.44 kg

Accessories *

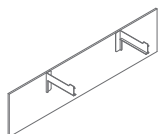

V16BM
1600 / 340 / 400
11 kg

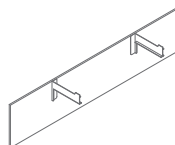

V18BM
1800 / 340 / 400
12 kg

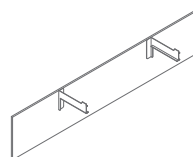

V20BM
2000 / 340 / 400
12.5 kg

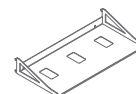

V34
550 / 280 / 85
3 kg

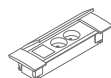

M06
245 / 80 / 50
1 kg

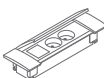

M06H
245 / 80 / 50
1 kg

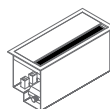

M04
275 / 120 / 140
1.6 kg

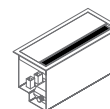

M04H
275 / 120 / 140
2 kg

* dimensions expressed in millimeters: width x depth x height

Accessories *

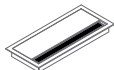

M05
275 / 120 / 25
0.3 kg

Desk with managerial cabinet *



V01M
1800 / 1000 / 740
55.79 kg

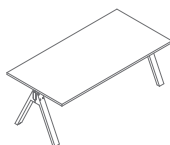

V02M
2000 / 1000 / 740
60.22 kg

Desks with managerial storage *

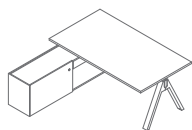

V03LM
1800 / 1800 / 740
115.79 kg

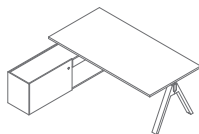

V04LM
2000 / 1800 / 740
120.22 kg

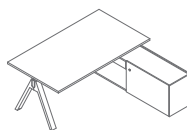

V03PM
1800 / 1800 / 740
115.79 kg

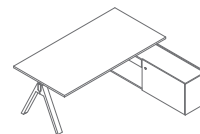

V04PM
2000 / 1800 / 740
120.22 kg

www.mdd.eu

Desk with managerial cabinet – cabinet with access from both sides *

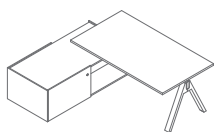

V05LM
1800 / 1000 / 740
149.79 kg

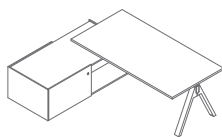

V06LM
2000 / 1000 / 740
154.22 kg

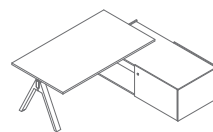

V05PM
1800 / 1000 / 740
149.79 kg

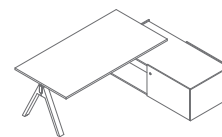

V06PM
2000 / 1000 / 740
154.22 kg

* dimensions expressed in millimeters: width x depth x height

Viga M	Date of preparation 30.05.2023	The data contained in this document is valid in the day of its preparation. Change of the product, as long as it does not affect the basic features of it, does not require consistent updates of the document.	page 12/20
			products

Desks with pedestal *

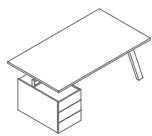

V07LM
1800 / 1000 / 740
135.29 kg

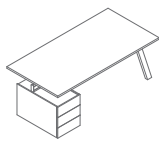

V08LM
2000 / 1000 / 740
102.72 kg

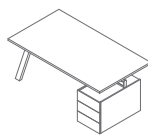

V07PM
1800 / 1000 / 740
135.29 kg

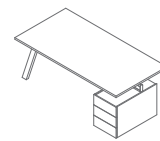

V08PM
2000 / 1000 / 740
102.72 kg

Desks with executive cabinet and pedestal *

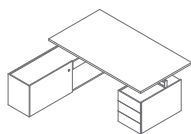

V09LM
1800 / 1800 / 740
158.296 kg

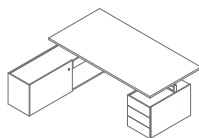

V10LM
2000 / 1800 / 740
203.22 kg

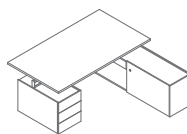

V09PM
1800 / 1800 / 740
158.29 kg

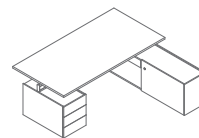

V10PM
2000 / 1800 / 740
203.22 kg

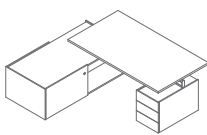

V37LM
2144 / 1800 / 740
192.29 kg

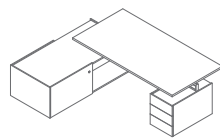

V38LM
2344 / 1800 / 740
196.72 kg

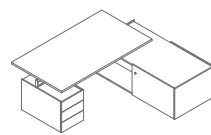

V37PM
2144 / 1800 / 740
192.29 kg

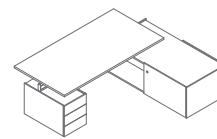

V38PM
2344 / 1800 / 740
196.72 kg

Managerial storages *

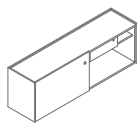

V35M
1602 / 416 / 545
62.5 kg

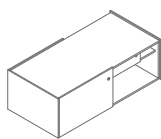

V36M
1602 / 784 / 545
96.5 kg

* dimensions expressed in millimeters: width x depth x height

Storages *

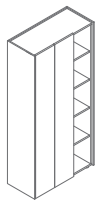

V22M
928 / 424 / 1944
110,5 kg

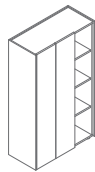

V23M
928 / 424 / 1565
82 kg

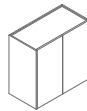

V24M
828 / 424 / 807
56 kg

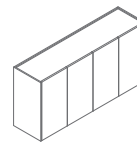

V25M
1628 / 424 / 807
104 kg



V26M
828 / 424 / 807
44 kg

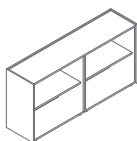

V27M
1628 / 424 / 807
79 kg



V28M
828 / 424 / 807
54 kg

Pedestals *

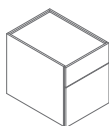

V12KM
438 / 600 / 545
35 kg

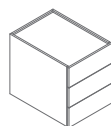

V13KM
438 / 600 / 545
35 kg

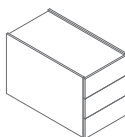

V14KM
438 / 800 / 545
45 kg

Additional elements *

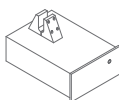

V11M
436 / 600 / 216
16,5 kg

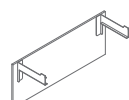

V10BM
1000 / 340 / 400
8 kg

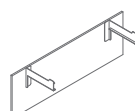

V12BM
1200 / 340 / 400
8,5 kg

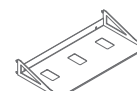

V34
550 / 280 / 85
3 kg

* dimensions expressed in millimeters: width x depth x height

Additional elements *

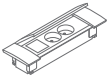

M06
245 / 80 / 50
1 kg

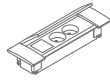

M06H
245 / 80 / 50
1 kg

* dimensions expressed in millimeters: width x depth x height

Viga M	Date of preparation 30.05.2023	The data contained in this document is valid in the day of its preparation. Change of the product, as long as it does not affect the basic features of it, does not require consistent updates of the document.	page 15/20
			products

Conference tables *



V220SM
2200 / 1100 / 740
65.44 kg

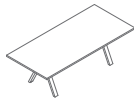

V240SM
2400 / 1100 / 740
123.1270.36

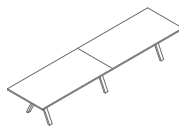

V440SM
4400 / 1100 / 740
130.88 kg

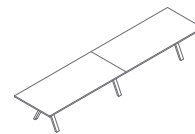

V480SM
4800 / 1100 / 740
245.74 kg

High tables *



V169M
1600 / 800 / 900
73.36 kg



V189M
1800 / 800 / 900
50.29 kg



V209M
2000 / 800 / 900
54.22 kg



V1611M
1600 / 800 / 1100
74.36 kg



V1811M
1800 / 800 / 1100
81.29 kg



V2011M
2000 / 800 / 1100
88.22 kg



V1619M
1600 / 1000 / 900
81.36 kg



V1819M
1800 / 1000 / 900
90.29 kg



V2019M
2000 / 1000 / 900
105.22 kg

* dimensions expressed in millimeters: width x depth x height

High tables *



V16111M
1600 / 1000 / 1100
51.36 kg



V18111M
1800 / 1000 / 1100
56.29 kg

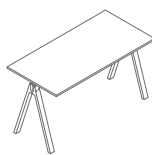

V20111M
2000 / 1000 / 1100
106.22 kg

Elements for pairing *



V169LM
1600 / 800 / 900
41.96 kg



V189LM
1800 / 800 / 900
45.89 kg



V209LM
2000 / 800 / 900
82.82 kg



V1611LM
1600 / 800 / 1100
69.66 kg



V1811LM
1800 / 800 / 1100
76.59 kg

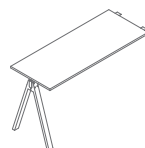

V2011LM
2000 / 800 / 1100
83.52 kg



V1619LM
1600 / 1000 / 900
76.96 kg



V1819LM
1800 / 1000 / 900
85.89 kg



V2019LM
2000 / 1000 / 900
100.82 kg

* dimensions expressed in millimeters: width x depth x height

Elements for pairing *



V16111LM
1600 / 1000 / 1100
46.66 kg



V18111LM
1800 / 1000 / 1100
51.59 kg



V20111LM
2000 / 1000 / 1100
59.52 kg

Accessories *

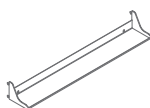

V21
700 / 120 / 85
1.8 kg

* dimensions expressed in millimeters: width x depth x height

Viga M	Date of preparation 30.05.2023	The data contained in this document is valid in the day of its preparation. Change of the product, as long as it does not affect the basic features of it, does not require consistent updates of the document.	page 18/20
			products

Desks, desk with managerial cabinet, managerial storage, conference tables, high tables

Top



Leg



Copplementary elements

Mediabox



Desks with managerial storage

Top, top and back wall, body inside, front



Sides of the cabinet



Leg



Additional elements

Suspended box-drawer, modesty panel



Mediabox



Storages

Top, sides of the cabinet



Bodyoutside, body inside, front



Pedestals

Top, front, body inside



Body outside

