

.mdd

Screens and modesty panels

v1 / 01.01.2023

Sonic - desktop screens	2
Twin - desktop screens	14
Sonic - free standing panels	25
Viva - free standing panel	30
Sonic - ceiling and wall screens	33
Bazalto - wall screens	39
Mix - ceiling and wall screens	41
Modesty panels	47

Colour combination - Sonic - desktop screens

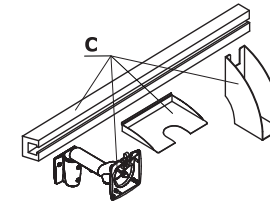
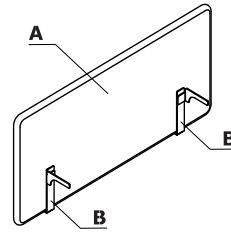
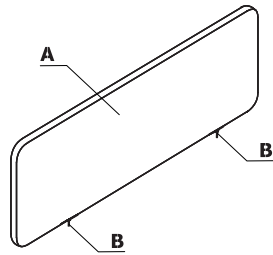

Material	Colour	Screens																
		A - Screen	B - Bracket	C - Accessories														
Fabric	Nemo	✓																
	Runner	II group ✓																
	Medley	II group ✓																
	**Atlantic	II group ✓																
	Vita	II group ✓																
	Mica	II group ✓																
	Go Check	II group ✓																
	****Charles	II group ✓																
	*Customer's own fabric	II group ✓																
	Synergy	III group ✓																
	***Silvertex	III group ✓																
	Tessa	III group ✓																
	Oceanic	III group ✓																
	Quest	III group ✓																
	Grain	III group ✓																
	Atlas	IV group ✓																

* Employing the customer's fabric requires running upholstery tests in order to check the possibility of realisation.

** There is a possibility of ordering the product in full colour spectrum of Atlantic range, as per Gabriel's pattern book, within 8 weeks

*** There is a possibility of ordering the product in full colour spectrum of Silvertex range, as per Spradling's pattern book, within 15 working days.

**** There is a possibility of ordering the product in full colour spectrum of Charles range, as per Dekoma pattern book, within the standard delivery time.

Material	Colour	Screens													
		A - Screen	B - Bracket	C - Accessories											
Metal	M009 - aluminium semi-matt RAL 9006		✓	✓											
	M015 - white semi-matt RAL 9010		✓												
	M115 - black semi-matt RAL 9005		✓												
	M154 - anthracite semi-matt RAL 7043		✓												

Desktop screens - for single and bench desks

- 1 **Sonic screens** - upholstered, acoustic class A, pinable
- 2 **Zip fastener**
- 3 **Frame** - glued solid wood structure
- 4 **Filling** - acoustic nonwoven with high sound absorption and dispersion properties
- 5 **Steel bracket** - situated in the frame with a machine screw thread to stabilize bracket fixing (concerns desk screens)

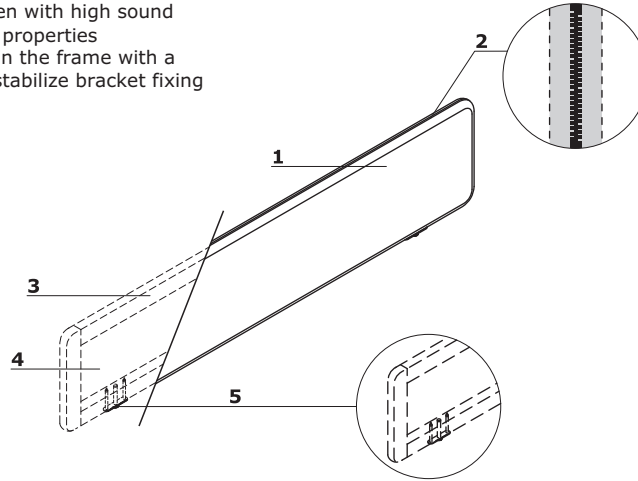

Ogi Drive handle - dimensions (mm)

- 1 **Ogi Drive screen bracket** - an option with extra charge; mountable to the frame; powder-coated metal, 60x60mm profile

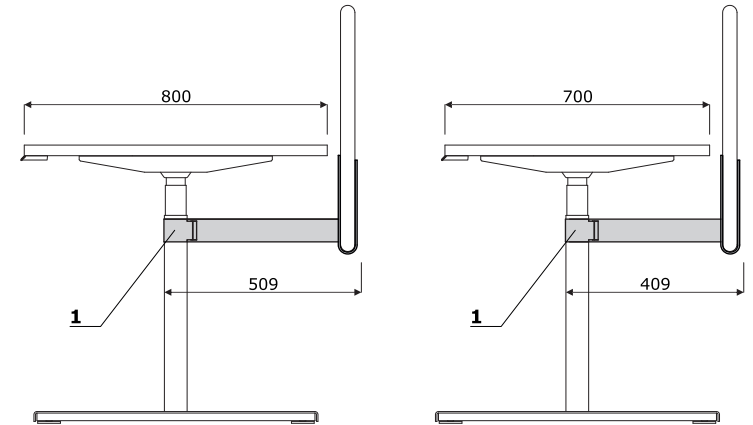

Caution - Ogi Drive screen bracket does not allow for pairing with screens equipped with accessories rail.

Screen fixings

- 1 **Ogi, Ergonomic Master** - panel fixing for single desks (OPTION WITH EXTRA CHARGE); suitable for mounting to 16-30mm thick worktops
- 2 **Ogi** - brackets for benches included; powder-coated steel; suitable for mounting to 16-30mm thick worktops

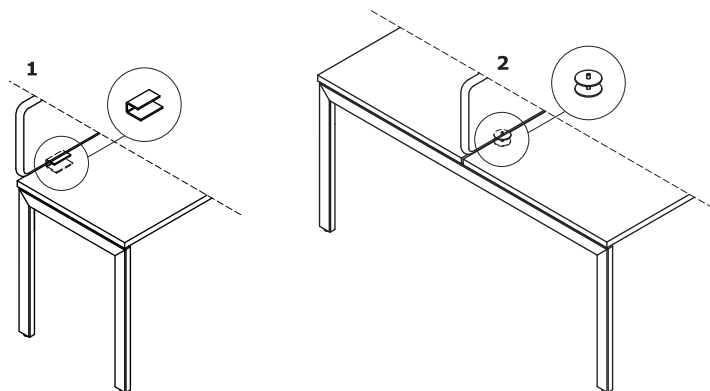

Screen brackets for sliding top desks

- 1 **Single desk bracket** - mountable to the metal beam
- 2 **Brackets for benches** - mountable to the metal beam

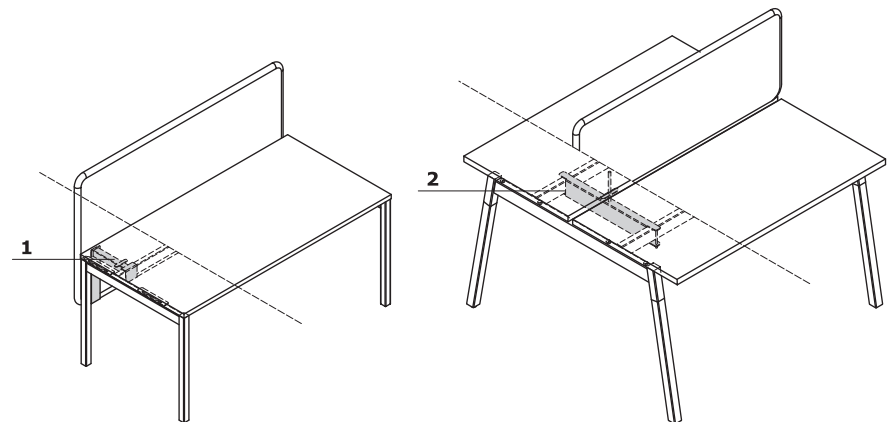

Attention - the screen should be mounted before the worktop assembly.

Desktop screens - for single desks

- 1 Fabric** - acoustic class A, pinable
- 2 Fixing element** - powder coated metal
- 3 Zip fastener**

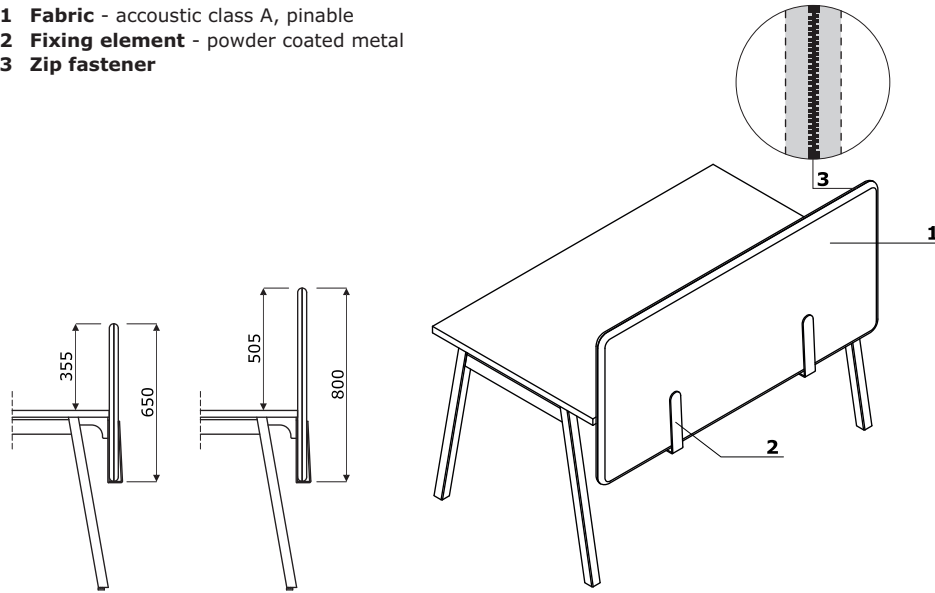

Side screens - for single and bench desks

- 1 Sonic screens** - acoustic class A, zip fastener, pinable
- 2 Fixing for side panels** - powder coated metal, colour: M009 - aluminium semi-matt

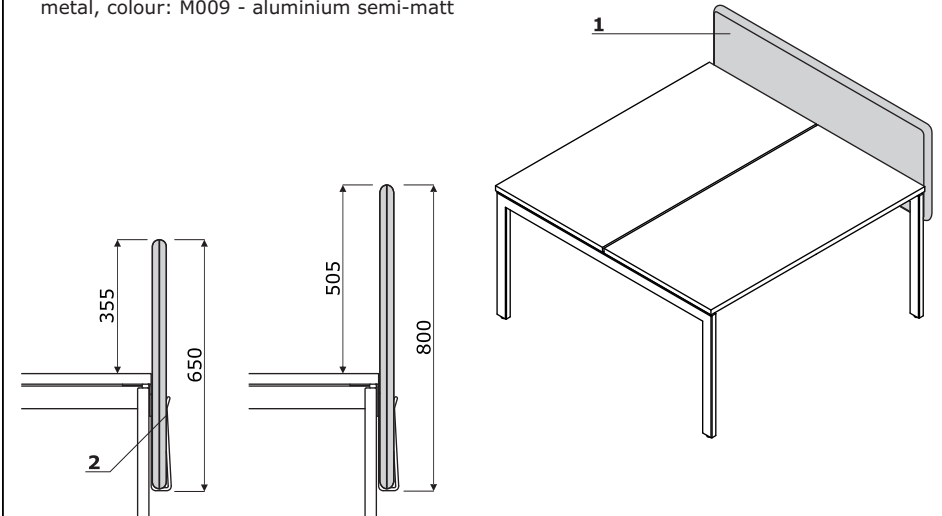

Partition screens - for bench desks

- 1 Sonic screens** - acoustic class A, pinnable, zip colour - graphite
- 2 Side screen fixings for Ogi desks** - foot 2 pcs

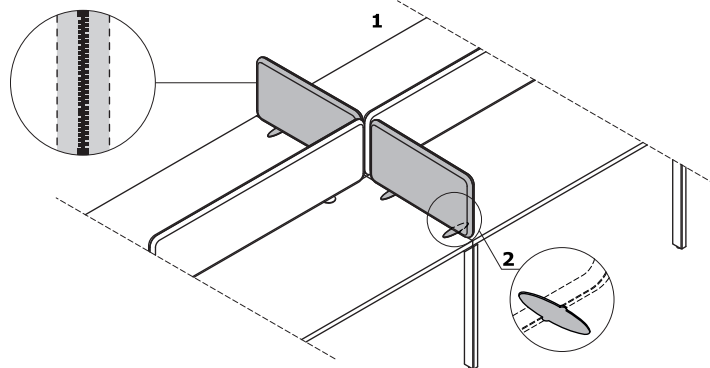

Accessories for function rail

- 1 Accessories rail** - max load: 3.5 kg per point, 7 kg per side
- 2 Monitor holder** - powder coated steel, colour: M009 - aluminium semi-matt
- 3 Pencil case** - powder coated steel
- 4 Shelf** - A4 size, powder coated steel
- 5 Organizer** - powder coated metal

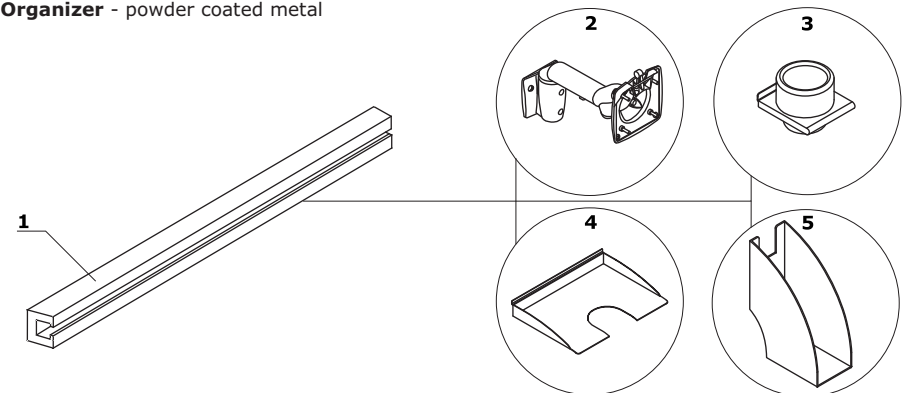

ATTENTION: Only accessories from .mdd offer can be mounted

Desktop screens - for single and bench desks						
Symbol	Price EUR	Dimensions			kg m3 pcs	Comments
		Width	Depth	Height		
ZUS01	172,-	990	40	350	4.1 kg 0.021 m3 2 pcs	for desks, width 1000 mm
ZUS12	182,-	1190	40	350	5.4 kg 0.024 m3 2 pcs	for 1200mm wide desks; possibility of fixing to single desks - option with extra charge
ZUS14	192,-	1390	40	350	6.1 kg 0.028 m3 2 pcs	for 1400 mm wide desks; possibility of fixing to single desks - option with extra charge
ZUS16	202,-	1590	40	350	6.8 kg 0.032 m3 2 pcs	for 1600mm wide desks; possibility of fixing to single desks - option with extra charge
ZUS18	222,-	1790	40	350	7.2 kg 0.035 m3 2 pcs	for 1800mm wide desks; possibility of fixing to single desks - option with extra charge
ZUS20	234,-	1990	40	350	8.2 kg 0.039 m3 2 pcs	for 2000mm wide desks; possibility of fixing to single desks - option with extra charge
ZUS05	222,-	990	40	500	4.8 kg 0.028 m3 2 pcs	for desks, width 1000 mm
ZUS52	234,-	1190	40	500	6 kg 0.033 m3 2 pcs	for 1200mm wide desks; possibility of fixing to single desks - option with extra charge
ZUS54	244,-	1390	40	500	7.1 kg 0.039 m3 2 pcs	for 1400mm wide desks; possibility of fixing to single desks - option with extra charge
ZUS56	264,-	1590	40	500	7.8 kg 0.047 m3 2 pcs	for 1600mm wide desks; possibility of fixing to single desks - option with extra charge
ZUS58	284,-	1790	40	500	8.4 kg 0.049 m3 2 pcs	for 1800mm wide desks; possibility of fixing to single desks - option with extra charge
ZUS59	304,-	1990	40	500	8.3 kg 0.054 m3 2 pcs	for 2000mm wide desks; possibility of fixing to single desks - option with extra charge

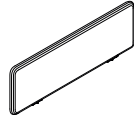

Extra charge						
II Price group	III Price group	Bracket to single desk	Hanging rail (1 PC.)	Hanging rail (2 PC.)	IV price group	
29,-	66,-	25,-	76,-	116,-	98,-	
33,-	78,-	25,-	76,-	116,-	110,-	
39,-	92,-	25,-	76,-	116,-	132,-	
44,-	102,-	25,-	76,-	116,-	144,-	
48,-	122,-	25,-	76,-	116,-	164,-	
54,-	132,-	25,-	76,-	116,-	184,-	
29,-	66,-	25,-	76,-	116,-	98,-	
33,-	78,-	25,-	76,-	116,-	110,-	
39,-	92,-	25,-	76,-	116,-	132,-	
44,-	102,-	25,-	76,-	116,-	144,-	
48,-	122,-	25,-	76,-	116,-	164,-	
54,-	132,-	25,-	76,-	116,-	184,-	

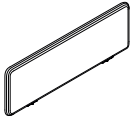
Desktop screens - for sliding top bench desks								Extra charge							
	Symbol	Price EUR	Dimensions			kg m3 pcs	Comments	II Price group	III Price group	Hanging rail (1 pc.)	Hanging rail (2 pc.)	IV price group			
			Width	Depth	Height										
	ZUS01S	228,-	990	40	350	6.1 kg 0.023 m3 2 pcs	for bench desks, width 1000 mm	29,-	66,-	76,-	116,-	98,-			
	ZUS12S	238,-	1190	40	350	7.4 kg 0.027 m3 2 pcs	for bench desks, width 1200 mm	33,-	78,-	76,-	116,-	110,-			
	ZUS14S	248,-	1390	40	350	8.1 kg 0.031 m3 2 pcs	for bench desks, width 1400 mm	39,-	92,-	76,-	116,-	132,-			
	ZUS16S	258,-	1590	40	350	8.8 kg 0.034 m3 2 pcs	for bench desks, width 1600 mm	44,-	102,-	76,-	116,-	144,-			
	ZUS18S	278,-	1790	40	350	9.2 kg 0.038 m3 2 pcs	for bench desks, width 1800 mm	48,-	122,-	76,-	116,-	164,-			
	ZUS20S	288,-	1990	40	350	10.2 kg 0.042 m3 2 pcs	for bench desks, width 2000 mm	54,-	132,-	76,-	116,-	184,-			
	ZUS05S	278,-	990	40	500	6.8 kg 0.031 m3 2 pcs	for bench desks, width 1000 mm	29,-	66,-	76,-	116,-	98,-			
	ZUS52S	288,-	1190	40	500	8 kg 0.036 m3 2 pcs	for bench desks, width 1200 mm	33,-	78,-	76,-	116,-	110,-			
	ZUS54S	298,-	1390	40	500	9.1 kg 0.041 m3 2 pcs	for bench desks, width 1400 mm	39,-	92,-	76,-	116,-	132,-			
	ZUS56S	318,-	1590	40	500	9.8 kg 0.05 m3 2 pcs	for bench desks, width 1600 mm	44,-	102,-	76,-	116,-	144,-			
	ZUS58S	336,-	1790	40	500	10.4 kg 0.052 m3 2 pcs	for bench desks, width 1800 mm	48,-	122,-	76,-	116,-	164,-			
	ZUS59S	358,-	1990	40	500	10.3 kg 0.057 m3 2 pcs	for bench desks, width 2000 mm	54,-	132,-	76,-	116,-	184,-			

Desktop screens - for single desks						
Symbol	Price EUR	Dimensions			kg m3 pcs	Comments
		Width	Depth	Height		
ZPS610	304,-	990	40	650	8.1 kg 0.039 m3 2 pcs	for single desks, width 1000 mm
ZPS612	320,-	1190	40	650	6.3 kg 0.041 m3 1 pcs	for single desks, width 1200 mm
ZPS614	352,-	1390	40	650	7.3 kg 0.048 m3 1 pcs	for single desks, width 1400 mm
ZPS616	372,-	1590	40	650	8 kg 0.054 m3 1 pcs	for single desks, width 1600 mm
ZPS618	394,-	1790	40	650	7.9 kg 0.061 m3 1 pcs	for single desks, width 1800 mm
ZPS620	422,-	1990	40	650	10 kg 0.067 m3 1 pcs	for single desks, width 2000 mm
ZPS810	314,-	990	40	800	9.1 kg 0.047 m3 2 pcs	for single desks, width 1000 mm
ZPS812	338,-	1190	40	800	7.6 kg 0.05 m3 1 pcs	for single desks, width 1200 mm
ZPS814	362,-	1390	40	800	8.3 kg 0.058 m3 1 pcs	for single desks, width 1400 mm
ZPS816	384,-	1590	40	800	9.1 kg 0.066 m3 1 pcs	for single desks, width 1600 mm
ZPS818	410,-	1790	40	800	9.6 kg 0.075 m3 1 pcs	for single desks, width 1800 mm
ZPS820	434,-	1990	40	800	10.5 kg 0.082 m3 1 pcs	for single desks, width 2000 mm

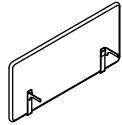

Extra charge						
II Price group	III Price group	Hanging rail (1 pc.)	IV price group	Ogi Drive handle - frame		
29,-	66,-	98,-	98,-	122,-		
33,-	78,-	98,-	110,-	122,-		
39,-	92,-	98,-	132,-	122,-		
44,-	102,-	98,-	144,-	122,-		
48,-	122,-	98,-	164,-	122,-		
54,-	132,-	98,-	184,-	122,-		
58,-	132,-	98,-	194,-	122,-		
66,-	154,-	98,-	224,-	122,-		
78,-	174,-	98,-	254,-	122,-		
88,-	204,-	98,-	286,-	122,-		
98,-	234,-	98,-	328,-	122,-		
102,-	254,-	98,-	360,-	122,-		

Desktop screens - for sliding top single desks						
Symbol	Price EUR	Dimensions			kg m3 pcs	Comments
		Width	Depth	Height		
ZPS610S	298,-	990	40	650	7 kg 0.039 m3 2 pcs	for single desks, width 1000 mm
ZPS612S	314,-	1190	40	650	7.1 kg 0.046 m3 2 pcs	for single desks, width 1200 mm
ZPS614S	342,-	1390	40	650	7 kg 0.053 m3 2 pcs	for single desks, width 1400 mm
ZPS616S	364,-	1590	40	650	8 kg 0.059 m3 2 pcs	for single desks, width 1600 mm
ZPS618S	386,-	1790	40	650	9.2 kg 0.066 m3 2 pcs	for single desks, width 1800 mm
ZPS620S	412,-	1990	40	650	11 kg 0.072 m3 2 pcs	for single desks, width 2000 mm
ZPS810S	308,-	990	40	800	8 kg 0.047 m3 2 pcs	for single desks, width 1000 mm
ZPS812S	330,-	1190	40	800	7 kg 0.055 m3 2 pcs	for single desks, width 1200 mm
ZPS814S	354,-	1390	40	800	9 kg 0.063 m3 2 pcs	for single desks, width 1400 mm
ZPS816S	374,-	1590	40	800	9.5 kg 0.072 m3 2 pcs	for single desks, width 1600 mm
ZPS818S	402,-	1790	40	800	10.5 kg 0.08 m3 2 pcs	for single desks, width 1800 mm
ZPS820S	424,-	1990	40	800	11.5 kg 0.088 m3 2 pcs	for single desks, width 2000 mm

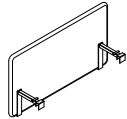



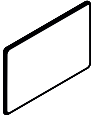
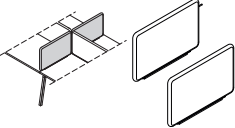
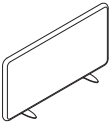

Extra charge							
II Price group	III Price group	Hanging rail (1 pc.)	IV price group				
29,-	66,-	98,-	98,-				
33,-	78,-	98,-	110,-				
39,-	92,-	98,-	132,-				
44,-	102,-	98,-	144,-				
48,-	122,-	98,-	164,-				
54,-	132,-	98,-	184,-				
58,-	132,-	98,-	194,-				
66,-	154,-	98,-	224,-				
78,-	174,-	98,-	254,-				
88,-	204,-	98,-	286,-				
98,-	234,-	98,-	328,-				
102,-	254,-	98,-	360,-				

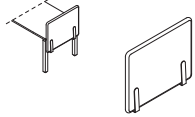
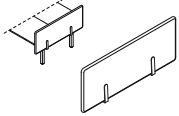
Desktop screens - for Ogi Drive bench desks							
	Symbol	Price EUR	Dimensions			kg m3 pcs	Comments
			Width	Depth	Height		
	ZD812	304,-	1190	40	800	6.1 kg 0.056 m3 2 pcs	for 1200mm wide benches only
	ZD814	338,-	1390	40	800	8.6 kg 0.064 m3 2 pcs	for 1400mm wide benches only
	ZD816	362,-	1590	40	800	7.9 kg 0.066 m3 1 pcs	for 1600mm wide benches only
	ZD818	384,-	1790	40	800	8.9 kg 0.08 m3 2 pcs	for 1800mm wide benches only
	ZD820	410,-	1990	40	800	9.3 kg 0.08 m3 2 pcs	for 2000mm wide benches only
	Partition screens - for Ogi bench desks						
	ZYS78	446,-	1600	40	350	12 kg 0.03 m3 2 pcs	for bench desks (set of 2 pcs);
	ZYS79	625,-	1600	40	500	6.6 kg 0.042 m3 2 pcs	
	ZOS58	160,-	577	40	350	3.5 kg 0.011 m3 1 pcs	for Ogi bench desks (1 pcs)
	ZOS68	166,-	677	40	350	2.7 kg 0.013 m3 1 pcs	
	ZOS78	172,-	780	40	350	3.2 kg 0.015 m3 1 pcs	
	ZOS10	234,-	577	40	500	3.1 kg 0.015 m3 1 pcs	
	ZOS40	240,-	677	40	500	3.4 kg 0.018 m3 1 pcs	
	ZOS79	244,-	780	40	500	3.7 kg 0.021 m3 1 pcs	

Extra charge							
II Price group	III Price group	IV price group					
66,-	154,-	224,-					
78,-	174,-	254,-					
88,-	204,-	286,-					
98,-	234,-	328,-					
102,-	254,-	360,-					
45,-	102,-	154,-					
45,-	102,-	154,-					
18,-	40,-	56,-					
21,-	46,-	66,-					
23,-	52,-	78,-					
18,-	40,-	56,-					
21,-	46,-	66,-					
23,-	52,-	78,-					

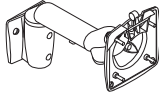
Side screens - for single desks							
	Symbol	Price EUR	Dimensions			kg m3 pcs	Comments
			Width	Depth	Height		
	ZUS80	284,-	600	40	650	4.5 kg 0.021 m3 1 pcs	screen height measured from the worktop – 350 mm
	ZUS90	290,-	700	40	650	4.6 kg 0.024 m3 1 pcs	
	ZUS30	294,-	800	40	650	5.2 kg 0.027 m3 1 pcs	
	ZUS60	362,-	600	40	800	7.7 kg 0.025 m3 1 pcs	screen height measured from the worktop – 500 mm
	ZUS70	366,-	700	40	800	5.4 kg 0.029 m3 1 pcs	
	ZUS50	372,-	800	40	800	6.1 kg 0.033 m3 1 pcs	
Side screens - for bench desks							
	ZUS11	294,-	1200	40	650	5.4 kg 0.041 m3 1 pcs	screen height measured from the worktop – 350 mm
	ZUS41	300,-	1400	40	650	7.1 kg 0.047 m3 1 pcs	
	ZUS31	304,-	1600	40	650	7.8 kg 0.053 m3 1 pcs	
	ZUS61	384,-	1200	40	800	7.5 kg 0.05 m3 1 pcs	screen height measured from the worktop – 500 mm
	ZUS71	388,-	1400	40	800	12 kg 0.058 m3 1 pcs	
	ZUS51	394,-	1600	40	800	9.1 kg 0.065 m3 1 pcs	

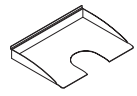
Extra charge							
II Price group	III Price group	IV price group					
19,-	41,-	62,-					
21,-	47,-	66,-					
24,-	54,-	78,-					
34,-	82,-	110,-					
40,-	92,-	132,-					
44,-	102,-	154,-					
33,-	78,-	110,-					
39,-	92,-	132,-					
44,-	102,-	144,-					
66,-	154,-	224,-					
78,-	174,-	254,-					
88,-	204,-	296,-					

Function rail accessories							
	Symbol	Price EUR	Dimensions			kg m3 pcs	Comments
			Width	Depth	Height		
	D1	348,-	300	130	130	1.9 kg 0.012 m3 1 pcs	PC holder, max monitor size 22"
	D5	36,-	164	83	146	0.2 kg 0.002 m3 1 pcs	Pencil case - plastic, colour: black, handle - metal, colour: grey
	D6	64,-	327	35	210	0.95 kg 0.002 m3 1 pcs	shelf A-4
	D7	84,-	93	250	180	0.6 kg 0.004 m3 1 pcs	organizer

Extra charge							

Colour combination - Twin - desktop screens

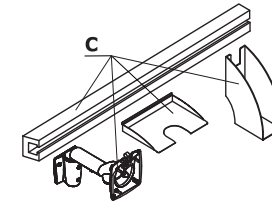
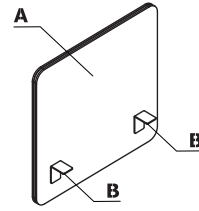
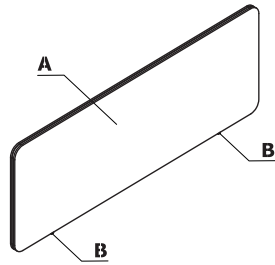

Material	Colour	Screens																
		A - Screen	B - Bracket	C - Accessories														
Fabric	Nemo	✓																
	Runner	II group ✓																
	Medley	II group ✓																
	**Atlantic	II group ✓																
	Vita	II group ✓																
	Mica	II group ✓																
	Go Check	II group ✓																
	****Charles	II group ✓																
	*Customer's own fabric	II group ✓																
	Synergy	III group ✓																
	***Silvertex	III group ✓																
	Tessa	III group ✓																
	Oceanic	III group ✓																
	Quest	III group ✓																
	Grain	III group ✓																
	Atlas	IV group ✓																

* Employing the customer's fabric requires running upholstery tests in order to check the possibility of realisation.

** There is a possibility of ordering the product in full colour spectrum of Atlantic range, as per Gabriel's pattern book, within 8 weeks

*** There is a possibility of ordering the product in full colour spectrum of Silvertex range, as per Spradling's pattern book, within 15 working days.

**** There is a possibility of ordering the product in full colour spectrum of Charles range, as per Dekoma pattern book, within the standard delivery time.

Material	Colour	Screens													
		A - Screen	B - Bracket	C - Accessories											
Metal	M009 - aluminium semi-matt RAL 9006		✓	✓											
	M015 - white semi-matt RAL 9010		✓												
	M115 - black semi-matt RAL 9005		✓												
	M154 - anthracite semi-matt RAL 7043		✓												

Desktop screens - for single and bench desks

- 1 Twin screens** - upholstered, drawing pin, strip colour: aluminum
- 2 Decorative element** - plastic stripe, colour: grey
- 3 Structure** - chipboard covered in polyurethane foam on both sides

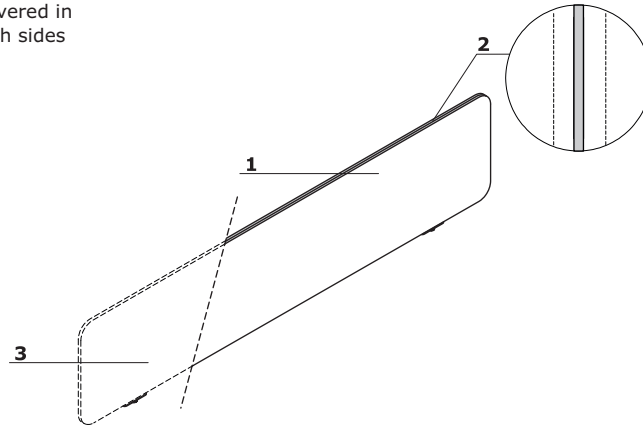

Screen brackets for sliding top desks

- 1 Single desk bracket** - mountable to the metal beam
- 2 Brackets for benches** - mountable to the metal beam

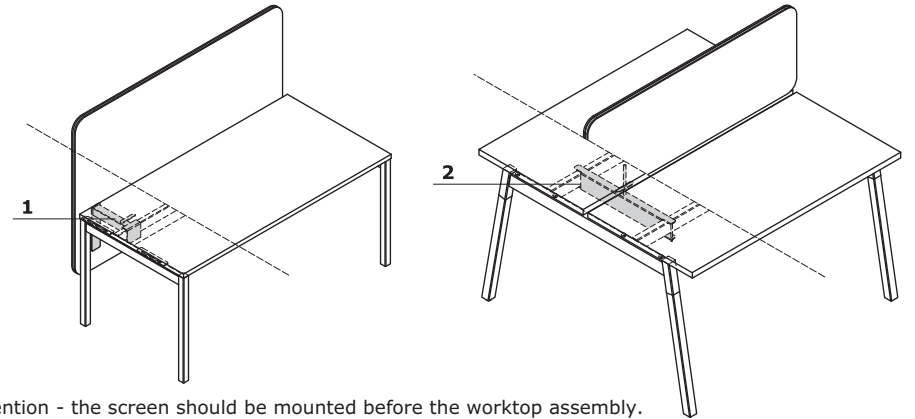

Screen fixings

- 1 Ogi, Ergonomic Master** - panel fixing for single desks (OPTION WITH EXTRA CHARGE); suitable for mounting to 16-30mm thick worktops
- 2 Ogi** - brackets for benches included; powder-coated steel; suitable for mounting to 16-30mm thick worktops

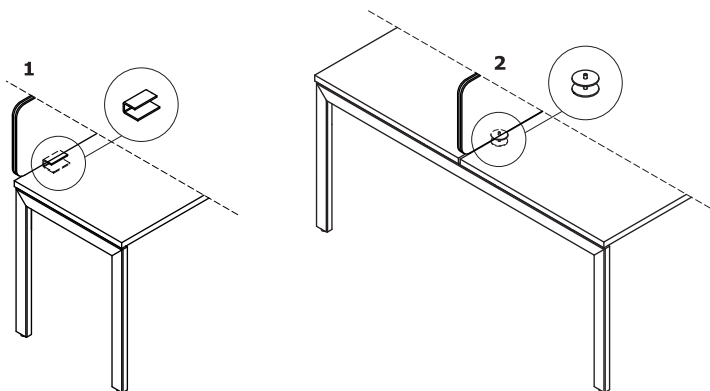

Partition screens - for bench desks

- 1 Twin screens** - upholstered, drawing pin, strip colour: aluminum
- 2 Side screen fixings for Ogi desks** - foot 2 pcs

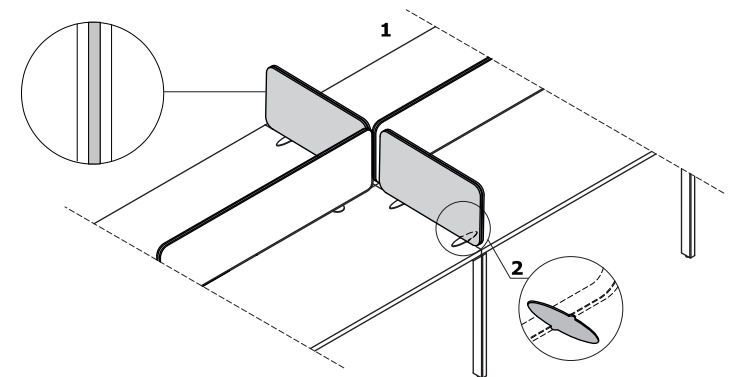

Side screens - for single and bench desks

- 1 **Fabric** - drawing pin
- 2 **Fixing for side panels** - powder coated metal, colour: M009 - aluminium semi-matt

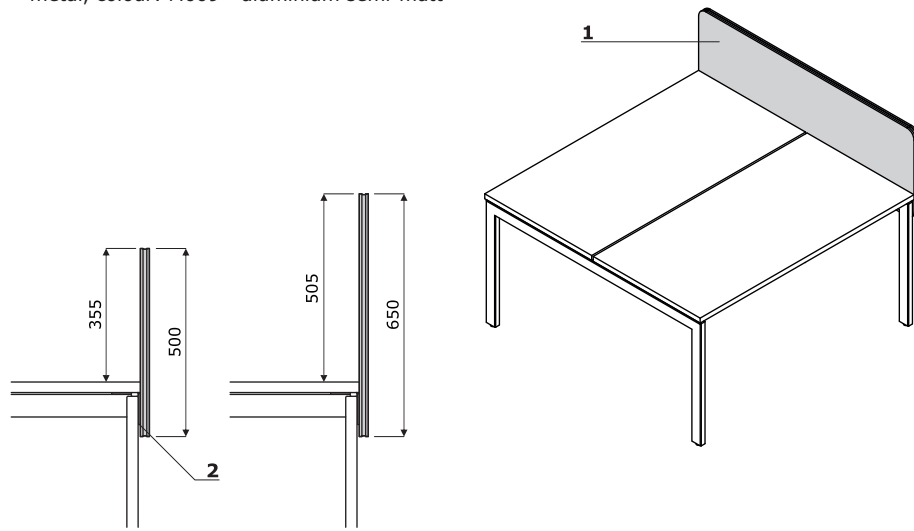

Accessories for function rail

- 1 **Accessories rail** - max load: 3.5 kg per point, 7 kg per side
- 2 **Monitor holder** - powder coated steel, colour: M009 - aluminium semi-matt
- 3 **Pencil case** - powder coated steel
- 4 **Shelf** - A4 size, powder coated steel
- 5 **Organizer** - powder coated metal

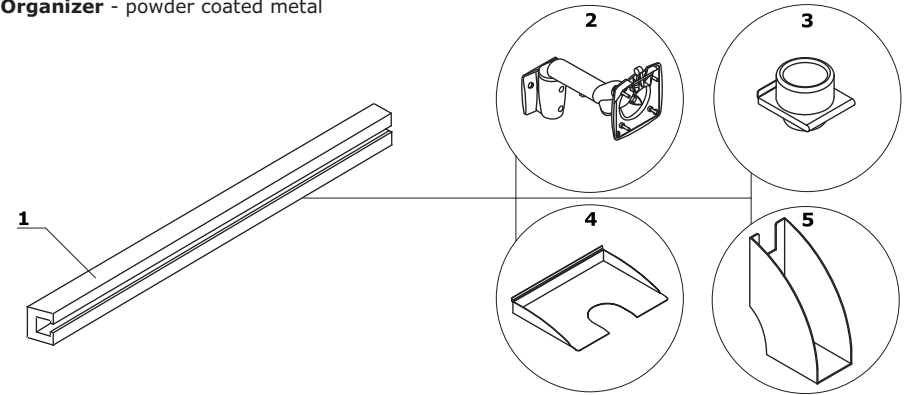

ATTENTION: Only accessories from .mdd offer can be mounted

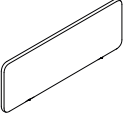
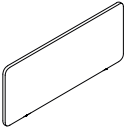
Desktop screens - for single and bench desks							
	Symbol	Price EUR	Dimensions			kg m3 pcs	Comments
			Width	Depth	Height		
	ZUT01	128,-	990	30	350	6.4 kg 0.016 m3 2 pcs	for desks, width 1000 mm
	ZUT12	132,-	1190	30	350	8.1 kg 0.019 m3 2 pcs	for 1200 mm wide desks;
	ZUT14	140,-	1390	30	350	9.6 kg 0.021 m3 2 pcs	for 1400 mm wide desks;
	ZUT16	144,-	1590	30	350	10.7 kg 0.024 m3 2 pcs	for 1600 mm wide desks;
	ZUT18	154,-	1790	30	350	10.9 kg 0.027 m3 2 pcs	for 1800 mm wide desks;
	ZUT20	160,-	1990	30	350	11.9 kg 0.029 m3 2 pcs	for 2000 mm wide desks;
	ZUT05	154,-	990	30	500	8.6 kg 0.02 m3 2 pcs	for desks, width 1000 mm
	ZUT52	160,-	1190	30	500	10.6 kg 0.024 m3 2 pcs	for 1200 mm wide desks;
	ZUT54	166,-	1390	30	500	13.3 kg 0.028 m3 2 pcs	for 1400mm wide desks;
	ZUT56	178,-	1590	30	500	14 kg 0.031 m3 2 pcs	for 1600mm wide desks;
	ZUT58	182,-	1790	30	500	15.3 kg 0.035 m3 2 pcs	for 1800mm wide desks;
	ZUT59	192,-	1990	30	500	16.4 kg 0.039 m3 2 pcs	for 2000mm wide desks;

Extra charge							
II Price group	III Price group	Bracket to single desk	Hanging rail (1 PC.)	Hanging rail (2 PC.)	IV price group		
29,-	66,-	25,-	48,-	98,-	98,-		
33,-	78,-	25,-	48,-	98,-	110,-		
38,-	88,-	25,-	48,-	98,-	132,-		
43,-	102,-	25,-	48,-	98,-	144,-		
48,-	110,-	25,-	48,-	98,-	164,-		
54,-	132,-	25,-	48,-	98,-	174,-		
29,-	66,-	25,-	48,-	98,-	98,-		
33,-	78,-	25,-	48,-	98,-	110,-		
38,-	88,-	25,-	48,-	98,-	132,-		
43,-	102,-	25,-	48,-	98,-	144,-		
48,-	110,-	25,-	48,-	98,-	164,-		
54,-	132,-	25,-	48,-	98,-	174,-		

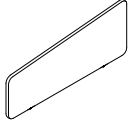
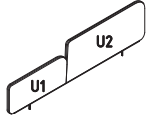
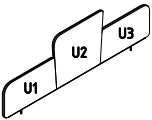
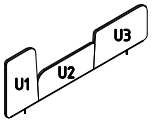
Desktop screens - for single and bench screens - asymmetrical panel							
	Symbol	Price EUR	Dimensions			kg m3 pcs	Comments
			Width	Depth	Height		
	ZUT02	154,-	990	30	350 450	8 kg 0.018 m3 2 pcs	for desks, width 1000 mm
	ZUT22	166,-	1190	30	350 450	8.6 kg 0.021 m3 2 pcs	for 1200 mm wide desks; asymmetrical panel
	ZUT24	178,-	1390	30	350 450	9.7 kg 0.025 m3 2 pcs	for 1400 mm wide desks; asymmetrical panel
	ZUT26	188,-	1590	30	350 450	11 kg 0.028 m3 2 pcs	for 1600 mm wide desks; asymmetrical panel
	ZUT28	198,-	1790	30	350 450	12.1 kg 0.035 m3 2 pcs	for 1800 mm wide desks; asymmetrical panel
	ZUT29	210,-	1990	30	350 450	14 kg 0.039 m3 2 pcs	for 2000 mm wide desks; asymmetrical panel
	Desktop screens - for bench screens						
	ZUT32	254,-	1190	30	360	7 kg 0.024 m3 1 pcs	for 1200 mm wide bench desks;
	ZUT34	272,-	1390	30	360	8.8 kg 0.018 m3 1 pcs	for 1400 mm wide bench desks;
	ZUT36	338,-	1590	30	560	11.9 kg 0.033 m3 1 pcs	for 1600 mm wide bench desks;
	ZUT38	356,-	1790	30	560	13 kg 0.037 m3 1 pcs	for 1800 mm wide bench desks;
	ZUT46	338,-	1590	30	560	10 kg 0.033 m3 1 pcs	for 1600 mm wide bench desks;
	ZUT48	356,-	1790	30	560	11.1 kg 0.037 m3 1 pcs	for 1800 mm wide bench desks;

Extra charge							
II Price group	III Price group	Bracket to single desk	Hanging rail (1 PC.)	Hanging rail (2 PC.)	IV price group		
29,-	66,-	25,-	48,-	98,-	98,-		
33,-	78,-	25,-	48,-	98,-	110,-		
38,-	88,-	25,-	48,-	98,-	132,-		
43,-	102,-	25,-	48,-	98,-	144,-		
48,-	110,-	25,-	48,-	98,-	164,-		
54,-	132,-	25,-	48,-	98,-	174,-		
34,-	82,-				110,-		
39,-	92,-				132,-		
47,-	110,-				154,-		
52,-	122,-				174,-		
47,-	110,-				154,-		
52,-	122,-				174,-		

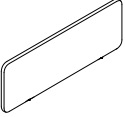
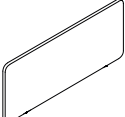
Desktop screens - for sliding top bench desks							
	Symbol	Price EUR	Dimensions			kg m3 pcs	Comments
			Width	Depth	Height		
	ZUT01S	184,-	990	30	350	8.4 kg 0.018 m3 2 pcs	for bench desks, width 1000 mm
	ZUT12S	188,-	1190	30	350	10.1 kg 0.021 m3 2 pcs	for bench desks, width 1200 mm
	ZUT14S	194,-	1390	30	350	11.6 kg 0.024 m3 2 pcs	for bench desks, width 1400 mm
	ZUT16S	198,-	1590	30	350	12.7 kg 0.027 m3 2 pcs	for bench desks, width 1600 mm
	ZUT18S	210,-	1790	30	350	12.9 kg 0.029 m3 2 pcs	for bench desks, width 1800 mm
	ZUT20S	216,-	1990	30	350	13.9 kg 0.032 m3 2 pcs	for bench desks, width 2000 mm
	ZUT05S	210,-	990	30	500	10.6 kg 0.023 m3 2 pcs	for bench desks, width 1000 mm
	ZUT52S	216,-	1190	30	500	12.6 kg 0.027 m3 2 pcs	for bench desks, width 1200 mm
	ZUT54S	222,-	1390	30	500	15.3 kg 0.03 m3 2 pcs	for bench desks, width 1400 mm
	ZUT56S	234,-	1590	30	500	16 kg 0.034 m3 2 pcs	for bench desks, width 1600 mm
	ZUT58S	238,-	1790	30	500	17.3 kg 0.038 m3 2 pcs	for bench desks, width 1800 mm
	ZUT59S	248,-	1990	30	500	18.4 kg 0.041 m3 2 pcs	for bench desks, width 2000 mm

Extra charge						
II Price group	III Price group	Hanging rail (1 PC.)	Hanging rail (2 PC.)	IV price group		
29,-	66,-	48,-	98,-	98,-		
33,-	78,-	48,-	98,-	110,-		
38,-	88,-	48,-	98,-	132,-		
43,-	102,-	48,-	98,-	144,-		
48,-	110,-	48,-	98,-	164,-		
54,-	132,-	48,-	98,-	174,-		
29,-	66,-	48,-	98,-	98,-		
33,-	78,-	48,-	98,-	110,-		
38,-	88,-	48,-	98,-	132,-		
43,-	102,-	48,-	98,-	144,-		
48,-	110,-	48,-	98,-	164,-		
54,-	132,-	48,-	98,-	174,-		

Desktop screens - for sliding top bench desks - asymmetrical panel						
Symbol	Price EUR	Dimensions			kg m3 pcs	Comments
		Width	Depth	Height		
ZUT02S	210,-	990	30	350 450	10 kg 0.021 m3 2 pcs	for bench desks, width 1000 mm
ZUT22S	222,-	1190	30	350 450	10.6 kg 0.024 m3 2 pcs	for bench desks, width 1200 mm, asymmetrical panel
ZUT24S	234,-	1390	30	350 450	11.7 kg 0.027 m3 2 pcs	for bench desks, width 1400 mm, asymmetrical panel
ZUT26S	244,-	1590	30	350 450	13 kg 0.03 m3 2 pcs	for bench desks, width 1600 mm, asymmetrical panel
ZUT28S	254,-	1790	30	350 450	14.1 kg 0.038 m3 2 pcs	for bench desks, width 1800 mm
ZUT29S	264,-	1990	30	350 450	16 kg 0.041 m3 2 pcs	for bench desks, width 2000 mm; asymmetrical panel

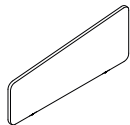

Extra charge							
II Price group	III Price group	Hanging rail (1 PC.)	Hanging rail (2 PC.)	IV price group			
29,-	66,-	48,-	98,-	98,-			
33,-	78,-	48,-	98,-	110,-			
38,-	88,-	48,-	98,-	132,-			
43,-	102,-	48,-	98,-	144,-			
48,-	110,-	48,-	98,-	164,-			
54,-	132,-	48,-	98,-	174,-			



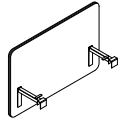

Desktop screens - for sliding top single desks						
Symbol	Price EUR	Dimensions			kg m3 pcs	Comments
		Width	Depth	Height		
ZPT610S	234,-	990	30	650	11.5 kg 0.031 m3 2 pcs	for single desks, width 1000 mm
ZPT612S	238,-	1190	30	650	13.5 kg 0.035 m3 2 pcs	for single desks, width 1200 mm
ZPT614S	244,-	1390	30	650	15.5 kg 0.04 m3 2 pcs	for single desks, width 1400 mm
ZPT616S	248,-	1590	30	650	17 kg 0.045 m3 2 pcs	for single desks, width 1600 mm
ZPT618S	254,-	1790	30	650	19 kg 0.049 m3 2 pcs	for single desks, width 1800 mm
ZPT620S	258,-	1990	30	650	20.5 kg 0.054 m3 2 pcs	for single desks, width 2000 mm
ZPT810S	268,-	990	30	800	13.5 kg 0.036 m3 2 pcs	for single desks, width 1000 mm
ZPT812S	278,-	1190	30	800	16 kg 0.042 m3 2 pcs	for single desks, width 1200 mm
ZPT814S	284,-	1390	30	800	18 kg 0.047 m3 2 pcs	for single desks, width 1400 mm
ZPT816S	288,-	1590	30	800	20.5 kg 0.053 m3 2 pcs	for single desks, width 1600 mm
ZPT818S	294,-	1790	30	800	22.5 kg 0.059 m3 2 pcs	for single desks, width 1800 mm
ZPT820S	298,-	1990	30	800	25 kg 0.064 m3 2 pcs	for single desks, width 2000 mm

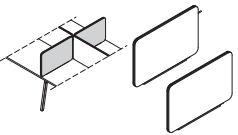
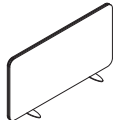
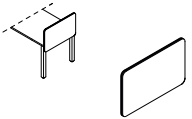

Extra charge							
II Price group	III Price group	Hanging rail (1 pc.)	IV price group				
29,-	66,-	98,-	98,-				
33,-	78,-	98,-	110,-				
39,-	92,-	98,-	132,-				
44,-	102,-	98,-	144,-				
48,-	122,-	98,-	164,-				
54,-	132,-	98,-	184,-				
58,-	132,-	98,-	194,-				
66,-	154,-	98,-	224,-				
78,-	174,-	98,-	254,-				
88,-	204,-	98,-	286,-				
98,-	234,-	98,-	328,-				
102,-	254,-	98,-	360,-				

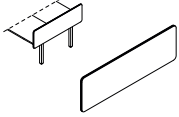
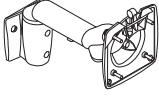
Partition screens - for bench desks							
	Symbol	Price EUR	Dimensions			kg m3 pcs	Comments
			Width	Depth	Height		
	ZYT78	188,-	1600	30	350	12 kg 0.014 m3 2 pcs	for bench desks (2 pcs)
	ZYT79	284,-	1600	30	500	12 kg 0.021 m3 2 pcs	
	ZOT58	108,-	577	30	350	3.4 kg 0.005 m3 1 pcs	for Ogi bench desks (1 pcs)
	ZOT68	116,-	677	30	350	3.9 kg 0.006 m3 1 pcs	
	ZOT78	120,-	777	30	350	4.5 kg 0.007 m3 1 pcs	
	ZOT10	160,-	577	30	500	5.3 kg 0.008 m3 1 pcs	
	ZOT40	166,-	677	30	500	5.4 kg 0.009 m3 1 pcs	
	ZOT79	166,-	777	30	500	6.3 kg 0.01 m3 1 pcs	
Side screens - for single desks							
	ZUT80	172,-	600	30	500	5.5 kg 0.011 m3 2 pcs	screen height measured from the worktop - 350 mm
	ZUT90	178,-	700	30	500	6.4 kg 0.013 m3 2 pcs	
	ZUT30	184,-	800	30	500	7.3 kg 0.014 m3 2 pcs	
	ZUT60	182,-	600	30	650	7 kg 0.014 m3 2 pcs	screen height measured from the worktop - 500 mm
	ZUT70	188,-	700	30	650	8.1 kg 0.016 m3 2 pcs	
	ZUT50	194,-	800	30	650	9 kg 0.018 m3 2 pcs	

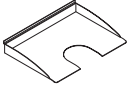
Extra charge							
II Price group	III Price group	IV price group					
45,-	102,-	154,-					
45,-	102,-	154,-					
18,-	40,-	56,-					
20,-	45,-	66,-					
23,-	52,-	72,-					
18,-	40,-	56,-					
20,-	45,-	66,-					
23,-	52,-	72,-					
19,-	41,-	56,-					
21,-	47,-	66,-					
23,-	52,-	78,-					
19,-	41,-	56,-					
21,-	47,-	66,-					
23,-	52,-	78,-					

Side screens - for bench desks							
	Symbol	Price EUR	Dimensions			kg m3 pcs	Comments
			Width	Depth	Height		
	ZUT11	228,-	1200	30	500	10.2 kg 0.02 m3 2 pcs	screen height measured from the worktop - 350 mm
	ZUT41	234,-	1400	30	500	11.8 kg 0.023 m3 2 pcs	
	ZUT31	240,-	1600	30	500	13.3 kg 0.026 m3 2 pcs	
	ZUT61	250,-	1200	30	650	12.7 kg 0.025 m3 2 pcs	screen height measured from the worktop - 500 mm
	ZUT71	254,-	1400	30	650	14.5 kg 0.029 m3 2 pcs	
	ZUT51	258,-	1600	30	650	17.2 kg 0.033 m3 2 pcs	
Function rail accessories							
	D1	348,-	300	130	130	1.9 kg 0.012 m3 1 pcs	PC holder, max monitor size 22"
	D5	36,-	164	83	146	0.2 kg 0.002 m3 1 pcs	Pencil case - plastic, colour: black, handle - metal, colour: grey
	D6	64,-	327	35	210	0.95 kg 0.002 m3 1 pcs	shelf A-4
	D7	84,-	93	250	180	0.6 kg 0.004 m3 1 pcs	organizer

Extra charge							
II Price group	III Price group	IV price group					
33,-	78,-	110,-					
39,-	88,-	132,-					
44,-	102,-	144,-					
33,-	78,-	110,-					
39,-	88,-	132,-					
44,-	102,-	144,-					

Colour combination - Sonic - free standing panels

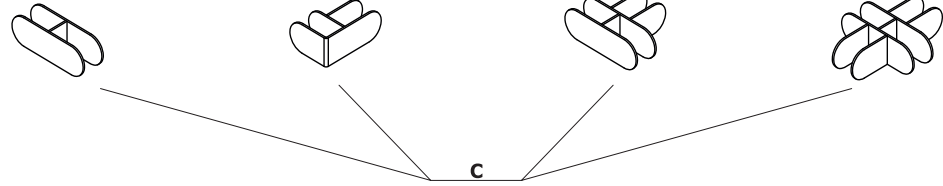
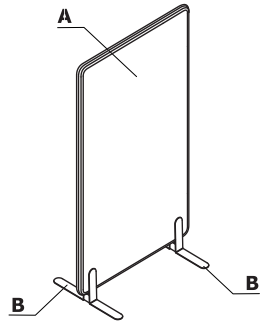

Material	Colour	Freestanding screens																
		A - Screen	B - Foot	C - Connecting element														
Fabric	Nemo	✓																
	Runner	II group ✓																
	Medley	II group ✓																
	**Atlantic	II group ✓																
	Vita	II group ✓																
	Mica	II group ✓																
	Go Check	II group ✓																
	****Charles	II group ✓																
	*Customer's own fabric	II group ✓																
	Synergy	III group ✓																
	***Silvertex	III group ✓																
	Tessa	III group ✓																
	Oceanic	III group ✓																
	Quest	III group ✓																
	Grain	III group ✓																
	Atlas	IV group ✓																

* Employing the customer's fabric requires running upholstery tests in order to check the possibility of realisation.
 ** There is a possibility of ordering the product in full colour spectrum of Atlantic range, as per Gabriel's pattern book, within 8 weeks
 *** There is a possibility of ordering the product in full colour spectrum of Silvertex range, as per Spradling's pattern book, within 15 working days.
 **** There is a possibility of ordering the product in full colour spectrum of Charles range, as per Dekoma pattern book, within the standard delivery time.

Material	Colour	Freestanding screens														
		A - Screen	B - Foot	C - Connecting element												
Metal	M009 - aluminium semi-matt RAL 9006		✓	✓												
	M015 - white semi-matt RAL 9010		✓													
	M115 - black semi-matt RAL 9005		✓													
	M154 - anthracite semi-matt RAL 7043		✓													

Freestanding screens

- 1 **Screen** - acoustic class A, upholstered; pinnable
- 2 **Zip fastener**
- 3 **Frame** - glued solid wood structure
- 4 **Filling** - acoustic nonwoven with high sound absorption and dispersion properties
- 5 **Freestanding feet** - powder coated metal
- 6 **Spacer** - powder coated metal; intended for use in screens situated between desks or other solid support from both sides
- 7 **Wheels with brake** - Ø65 mm
- 8 **Magnetic dry** - wipe whiteboard

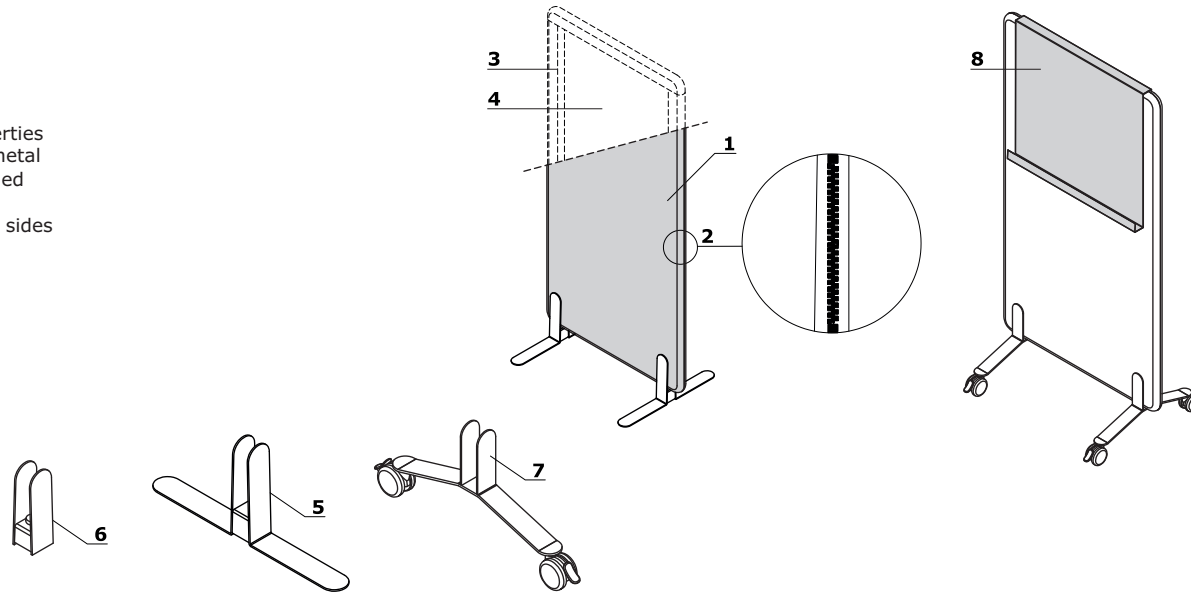



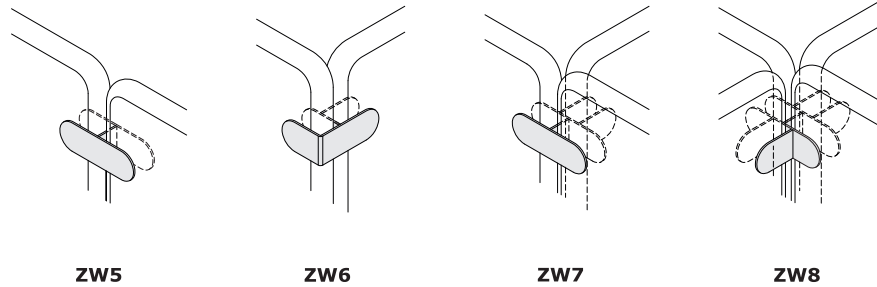

Sonic - connecting element for free standing screens

- 1 **Connector** - powder-coated steel

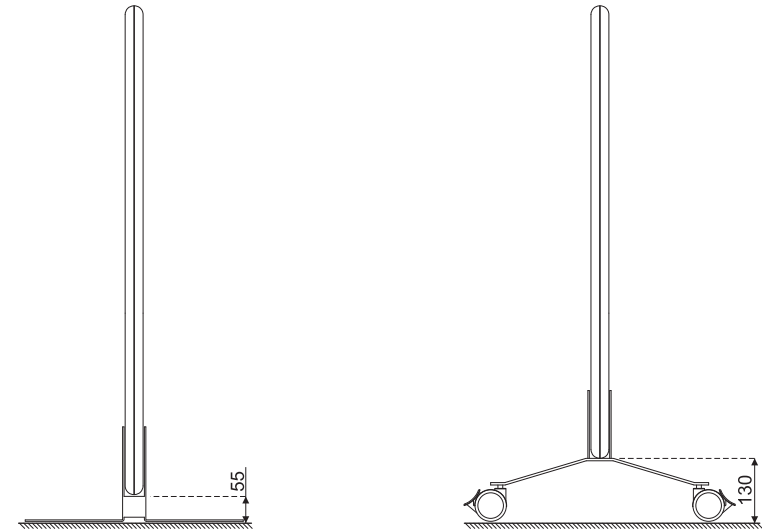



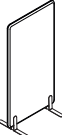
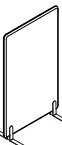

Dimensions (mm)

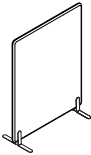

Freestanding screens							
	Symbol	Price EUR	Dimensions			kg m3 pcs	Comments
			Width	Depth	Height		
	ZW592	290,-	590	40	1250	8.3 kg 0.046 m3 2 pcs	
	ZW594	314,-	590	40	1450	8.1 kg 0.052 m3 2 pcs	
	ZW596	356,-	590	40	1650	9 kg 0.058 m3 2 pcs	
	ZW598	384,-	590	40	1850	9.4 kg 0.064 m3 2 pcs	
	ZW692	310,-	690	40	1250	7.5 kg 0.052 m3 2 pcs	
	ZW694	352,-	690	40	1450	8.7 kg 0.059 m3 2 pcs	
	ZW696	384,-	690	40	1650	9.7 kg 0.066 m3 2 pcs	
	ZW698	416,-	690	40	1850	10.4 kg 0.073 m3 2 pcs	
	ZW792	346,-	790	40	1250	8.5 kg 0.058 m3 2 pcs	
	ZW794	376,-	790	40	1450	9.4 kg 0.066 m3 2 pcs	
	ZW796	416,-	790	40	1650	11.3 kg 0.074 m3 2 pcs	
	ZW798	462,-	790	40	1850	12 kg 0.082 m3 2 pcs	
	ZW892	366,-	890	40	1250	9.2 kg 0.064 m3 2 pcs	
	ZW894	404,-	890	40	1450	10.8 kg 0.073 m3 2 pcs	
	ZW896	456,-	890	40	1650	11 kg 0.082 m3 2 pcs	
	ZW898	496,-	890	40	1850	11.2 kg 0.091 m3 2 pcs	

Extra charge							
II Price group	III Price group	IV price group	Castor foot / feet				
36,-	82,-	122,-	58,-				
41,-	98,-	144,-	58,-				
46,-	110,-	154,-	58,-				
52,-	122,-	174,-	58,-				
36,-	82,-	122,-	58,-				
41,-	98,-	144,-	58,-				
46,-	110,-	154,-	58,-				
52,-	122,-	174,-	58,-				
72,-	164,-	244,-	58,-				
82,-	194,-	274,-	58,-				
92,-	224,-	306,-	58,-				
102,-	244,-	350,-	58,-				
72,-	164,-	244,-	58,-				
82,-	194,-	274,-	58,-				
92,-	224,-	306,-	58,-				
102,-	244,-	350,-	58,-				

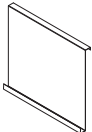
Freestanding screens							
	Symbol	Price EUR	Dimensions			kg m3 pcs	Comments
			Width	Depth	Height		
	ZW992	394,-	990	40	1250	11.7 kg 0.075 m3 3 pcs	
	ZW994	438,-	990	40	1450	12.5 kg 0.085 m3 3 pcs	
	ZW996	484,-	990	40	1650	13.8 kg 0.095 m3 3 pcs	
	ZW998	540,-	990	40	1850	15.8 kg 0.105 m3 3 pcs	
Sonic - connecting element for free standing screens							
	ZW5	25,-	150	37 36.5	50	0.37 kg 0 m3 1 pcs	
	ZW6	30,-	150	116	50	0.37 kg 0.001 m3 1 pcs	
	ZW7	37,-	150	116	50	0.53 kg 0.001 m3 1 pcs	
	ZW8	48,-	150	190 189.5	50	0.69 kg 0.001 m3 1 pcs	
Accessories							
	TB01	132,-	700	92	635	4.5 kg 0.046 m3 1 pcs	magnetic dry-wipe whiteboard

Extra charge							
II Price group	III Price group	IV price group	Castor foot / feet				
72,-	164,-	244,-	58,-				
82,-	194,-	274,-	58,-				
92,-	224,-	306,-	58,-				
102,-	244,-	350,-	58,-				

Colour combination - Viva - free standing panel

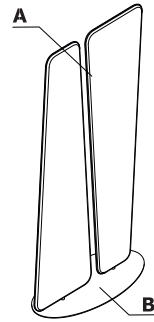

Material	Colour	Freestanding screens															
		A - Screen	B - Frame														
Fabric	Nemo	✓															
	Runner	II group ✓															
	Medley	II group ✓															
	**Atlantic	II group ✓															
	Vita	II group ✓															
	Mica	II group ✓															
	Go Check	II group ✓															
	****Charles	II group ✓															
	*Customer's own fabric	II group ✓															
	Synergy	III group ✓															
	***Silvertex	III group ✓															
	Tessa	III group ✓															
	Oceanic	III group ✓															
	Quest	III group ✓															
	Grain	III group ✓															
	Atlas	IV group ✓															

* Employing the customer's fabric requires running upholstery tests in order to check the possibility of realisation.

** There is a possibility of ordering the product in full colour spectrum of Atlantic range, as per Gabriel's pattern book, within 8 weeks

*** There is a possibility of ordering the product in full colour spectrum of Silvertex range, as per Spradling's pattern book, within 15 working days.

**** There is a possibility of ordering the product in full colour spectrum of Charles range, as per Dekoma pattern book, within the standard delivery time.

Material	Colour	Freestanding screens													
		A - Screen	B - Frame												
Metal	M009 - aluminium semi-matt RAL 9006		✓												
	M015 - white semi-matt RAL 9010		✓												
	M115 - black semi-matt RAL 9005		✓												
	M154 - anthracite semi-matt RAL 7043		✓												

Freestanding screens

- 1 Screen** - upholstered, Sonic technology structure with A-class acoustics certificate, pinnable
- 2 Zip fastener**
- 3 Frame** - steel pipe
- 4 Filling** - acoustic nonwoven with high sound absorption and dispersion properties
- 5 Foot** - powder coated metal
- 6 Rotation 360°** - each panel rotates independently

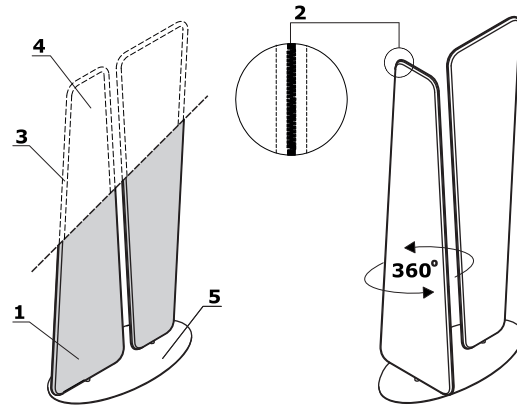

Dimensions (mm)

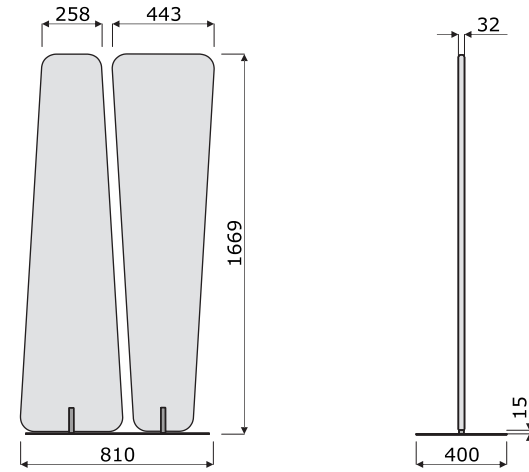

Freestanding screens

	Symbol	Price EUR	Dimensions			kg m3 pcs	Comments
			Width	Depth	Height		
	VV02	650,-	850	400	1670	21.3 kg 0.084 m3 3 pcs	

Extra charge							

Colour combination - Sonic - ceiling and wall screens

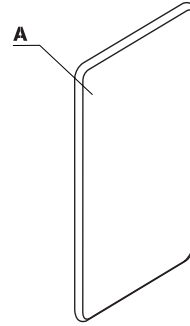

Material	Colour	Screens													
		A - Screen													
Fabric	Nemo	✓													
	Runner	II group ✓													
	Medley	II group ✓													
	**Atlantic	II group ✓													
	Vita	II group ✓													
	Mica	II group ✓													
	Go Check	II group ✓													
	****Charles	II group ✓													
	*Customer's own fabric	II group ✓													
	Synergy	III group ✓													
	***Silvertex	III group ✓													
	Tessa	III group ✓													
	Oceanic	III group ✓													
	Quest	III group ✓													
	Grain	III group ✓													
	Atlas	IV group ✓													

* Employing the customer's fabric requires running upholstery tests in order to check the possibility of realisation.
 ** There is a possibility of ordering the product in full colour spectrum of Atlantic range, as per Gabriel's pattern book, within 8 weeks
 *** There is a possibility of ordering the product in full colour spectrum of Silvertex range, as per Spradling's pattern book, within 15 working days.
 **** There is a possibility of ordering the product in full colour spectrum of Charles range, as per Dekoma pattern book, within the standard delivery time.

Sonic - Wall-mounted acoustic screen

- 1 Screen** - one-side upholstery, Sonic technology structure with A-class acoustics certificate, pinnable
- 2 Frame** - glued solid wood structure
- 3 Filling** - acoustic nonwoven with high sound absorption and dispersion properties
- 4 Wall hanger (set includes plugs for solid and plasterboard walls)**

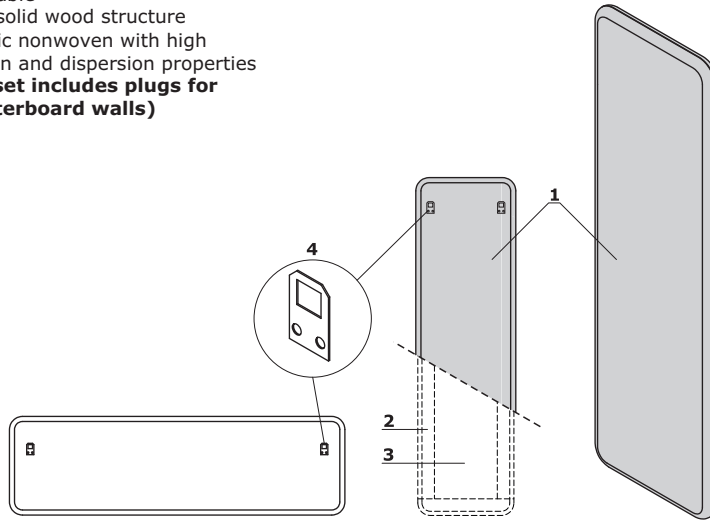

Sonic - ceiling acoustic screen

- 1 Ceiling screens** - one-side upholstery, Sonic technology structure with A-class acoustics certificate
- 2 Wire rope** - stainless steel, adjustable length of screens hanging vertically in the scope of 100 - 900 mm and of screens hanging horizontally in the scope of 200 - 1400 mm.

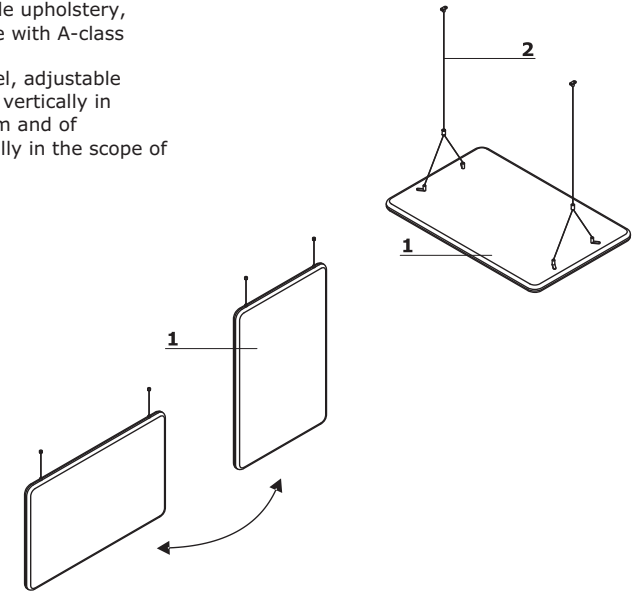

Sonic - ceiling screen - rail for hanging screens

- 1 Joining rail** - aluminium, 2 units
- 2 Fixing element**

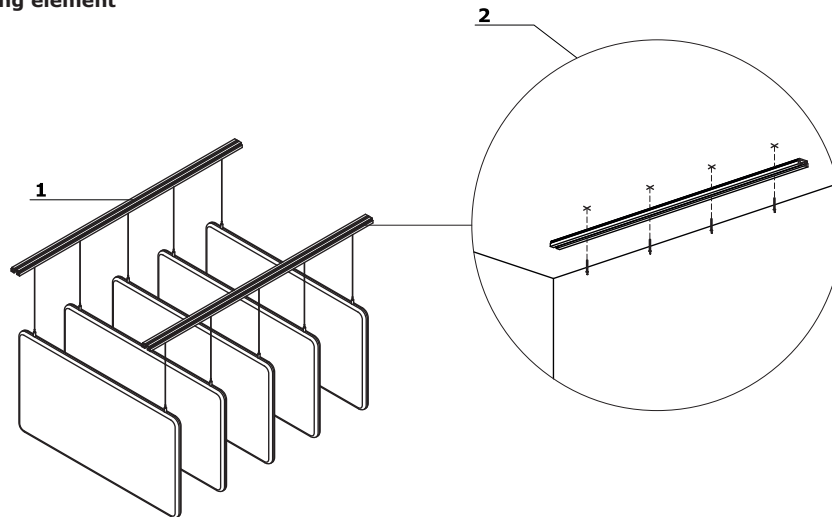

ATTENTION - rawplugs for concrete ceilings with ITB approval – A1 fire resistance.

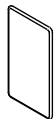
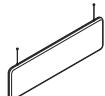
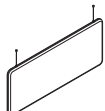
Sonic - Wall-mounted acoustic screen							
	Symbol	Price EUR	Dimensions			kg m3 pcs	Comments
			Width	Depth	Height		
	ZAK312	178,-	350	40	1190	4 kg 0.023 m3 1 pcs	horizontal and vertical mounting; one-side upholstery
	ZAK318	210,-	350	40	1790	6.2 kg 0.034 m3 1 pcs	
	ZAK612	310,-	650	40	1190	5.1 kg 0.041 m3 1 pcs	
	ZAK618	384,-	650	40	1790	6.9 kg 0.061 m3 1 pcs	
Sonic - ceiling screens - fixing to the ceiling with the long edge							
	ZUS12G	170,-	1190	40	350	10 kg 0.027 m3 1 pcs	Product with no installation. Will not be included in general installation costs.
	ZUS14G	180,-	1390	40	350	10 kg 0.031 m3 1 pcs	
	ZUS16G	190,-	1590	40	350	10 kg 0.036 m3 1 pcs	
	ZUS18G	202,-	1790	40	350	10 kg 0.04 m3 1 pcs	
	ZUS20G	214,-	1990	40	350	10 kg 0.045 m3 1 pcs	
Sonic - ceiling screens - fixing to the ceiling with the long or short edge							
	ZUS05G	196,-	990	40	500	10 kg 0.032 m3 1 pcs	Product with no installation. Will not be included in general installation costs.
	ZUS52G	206,-	1190	40	500	10 kg 0.038 m3 1 pcs	
	ZUS54G	222,-	1390	40	500	10 kg 0.044 m3 1 pcs	
	ZUS56G	232,-	1590	40	500	10 kg 0.05 m3 1 pcs	
	ZUS58G	246,-	1790	40	500	10 kg 0.056 m3 1 pcs	
	ZUS59G	262,-	1990	40	500	10 kg 0.063 m3 1 pcs	

Extra charge									
II Price group	III Price group	IV price group							
20,-	44,-	62,-							
24,-	56,-	78,-							
37,-	88,-	122,-							
52,-	122,-	174,-							
33,-	78,-	110,-							
39,-	92,-	132,-							
44,-	102,-	144,-							
48,-	122,-	164,-							
54,-	132,-	184,-							
29,-	66,-	98,-							
33,-	78,-	110,-							
39,-	92,-	132,-							
44,-	102,-	144,-							
48,-	122,-	164,-							
54,-	132,-	184,-							

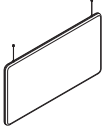
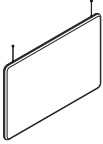
Sonic - ceiling screens - fixing to the ceiling with the long or short edge							
	Symbol	Price EUR	Dimensions			kg m3 pcs	Comments
			Width	Depth	Height		
	ZPS610G	228,-	990	40	650	10 kg 0.041 m3 1 pcs	Product with no installation. Will not be included in general installation costs.
	ZPS612G	240,-	1190	40	650	10 kg 0.049 m3 1 pcs	
	ZPS614G	254,-	1390	40	650	10 kg 0.057 m3 1 pcs	
	ZPS616G	266,-	1590	40	650	10 kg 0.065 m3 1 pcs	
	ZPS618G	278,-	1790	40	650	10 kg 0.073 m3 1 pcs	
	ZPS620G	294,-	1990	40	650	10 kg 0.081 m3 1 pcs	
	ZPS810G	240,-	990	40	800	10 kg 0.05 m3 1 pcs	Product with no installation. Will not be included in general installation costs.
	ZPS812G	254,-	1190	40	800	10 kg 0.06 m3 1 pcs	
	ZPS814G	274,-	1390	40	800	10 kg 0.069 m3 1 pcs	
	ZPS816G	296,-	1590	40	800	10 kg 0.079 m3 1 pcs	
	ZPS818G	318,-	1790	40	800	10 kg 0.089 m3 1 pcs	
	ZPS820G	336,-	1990	40	800	10 kg 0.099 m3 1 pcs	

Extra charge						
II Price group	III Price group	IV price group				
29,-	66,-	98,-				
33,-	78,-	110,-				
39,-	92,-	132,-				
44,-	102,-	144,-				
48,-	122,-	164,-				
54,-	132,-	184,-				
58,-	132,-	194,-				
66,-	154,-	224,-				
78,-	174,-	254,-				
88,-	204,-	286,-				
98,-	234,-	328,-				
102,-	254,-	360,-				

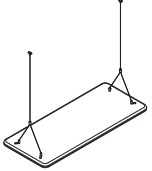
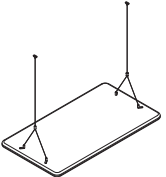
Sonic - ceiling screens - fixed horizontally							
	Symbol	Price EUR	Dimensions			kg m3 pcs	Comments
			Width	Depth	Height		
	ZUS05GP	176,-	990	40	500	10 kg 0.032 m3 1 pcs	Product with no installation. Will not be included in general installation costs.
	ZUS52GP	188,-	1190	40	500	10 kg 0.038 m3 1 pcs	
	ZUS54GP	200,-	1390	40	500	10 kg 0.044 m3 1 pcs	
	ZUS56GP	210,-	1590	40	500	10 kg 0.05 m3 1 pcs	
	ZUS58GP	222,-	1790	40	500	10 kg 0.056 m3 1 pcs	
	ZUS59GP	236,-	1990	40	500	10 kg 0.063 m3 1 pcs	
	ZPS610GP	204,-	990	40	650	10 kg 0.041 m3 1 pcs	Product with no installation. Will not be included in general installation costs.
	ZPS612GP	216,-	1190	40	650	10 kg 0.049 m3 1 pcs	
	ZPS614GP	228,-	1390	40	650	10 kg 0.057 m3 1 pcs	
	ZPS616GP	240,-	1590	40	650	10 kg 0.065 m3 1 pcs	
	ZPS618GP	252,-	1790	40	650	10 kg 0.073 m3 1 pcs	
	ZPS620GP	264,-	1990	40	650	10 kg 0.081 m3 1 pcs	

Extra charge						
II Price group	III Price group	IV price group				
29,-	66,-	98,-				
33,-	78,-	110,-				
39,-	92,-	132,-				
44,-	102,-	144,-				
48,-	122,-	164,-				
54,-	132,-	184,-				
29,-	66,-	98,-				
33,-	78,-	110,-				
39,-	92,-	132,-				
44,-	102,-	144,-				
48,-	122,-	164,-				
54,-	132,-	184,-				

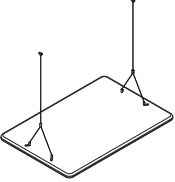
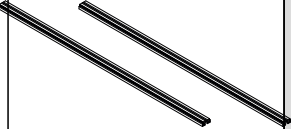
Sonic - ceiling screens - fixed horizontally							
	Symbol	Price EUR	Dimensions			kg m3 pcs	Comments
			Width	Depth	Height		
	ZPS810GP	216,-	990	40	800	10 kg 0.05 m3 1 pcs	Product with no installation. Will not be included in general installation costs.
	ZPS812GP	228,-	1190	40	800	10 kg 0.06 m3 1 pcs	
	ZPS814GP	248,-	1390	40	800	10 kg 0.069 m3 1 pcs	
	ZPS816GP	266,-	1590	40	800	10 kg 0.079 m3 1 pcs	
	ZPS818GP	286,-	1790	40	800	10 kg 0.089 m3 1 pcs	
	ZPS820GP	302,-	1990	40	800	10 kg 0.099 m3 1 pcs	
	Accessories						
	ZSZ200	0,-	2000	30	30	0 kg 0 m3 0 pcs	rail for hanging ceiling screen (2 pcs)

Extra charge							
II Price group	III Price group	IV price group					
58,-	132,-	194,-					
66,-	154,-	224,-					
78,-	174,-	254,-					
88,-	204,-	286,-					
98,-	234,-	328,-					
102,-	254,-	360,-					

Colour combination - Bazalto - wall screens

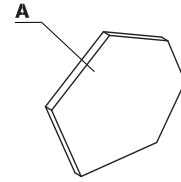

Material	Colour	Screens												
		A - Screen												
Fabric	Nemo	✓												
	Runner	II group ✓												
	Medley	II group ✓												
	**Atlantic	II group ✓												
	Vita	II group ✓												
	Mica	II group ✓												
	Go Check	II group ✓												
	****Charles	II group ✓												
	Synergy	III group ✓												
	***Silvertex	III group ✓												
	Tessa	III group ✓												
	Oceanic	III group ✓												
	Quest	III group ✓												
	Grain	III group ✓												
	*Customer's own fabric	II group ✓												
	Atlas	IV group ✓												

* Employing the customer's fabric requires running upholstery tests in order to check the possibility of realisation.

** There is a possibility of ordering the product in full colour spectrum of Atlantic range, as per Gabriel's pattern book, within 8 weeks

*** There is a possibility of ordering the product in full colour spectrum of Silvertex range, as per Spradling's pattern book, within 15 working days.

**** There is a possibility of ordering the product in full colour spectrum of Charles range, as per Dekoma pattern book, within the standard delivery time.

Bazalto - Wall-mounted screen

- Screen** - one-side upholstery, Sonic technology structure with A-class acoustics certificate, pinnable
- Frame** - chipboard
- Filling** - acoustic nonwoven with high sound absorption and dispersion properties
- Fixing element** - glue (1 pack is enough for 6 panels) - order separately (BKL1)

Bazalto - Wall-mounted screen							
	Symbol	Price EUR	Dimensions			kg m3 pcs	Comments
			Width	Depth	Height		
	BWP1	72,-	650	21	550	1.7 kg 0.01 m3 1 pcs	in the case of choosing MDD installation, it's obligatory to order the glue BKL1
	BWP2	88,-	650	39	550	2.3 kg 0.019 m3 1 pcs	
Mounting glue							
	BKL1	24,-	220	50	50	0.4 kg 0.001 m3 1 pcs	panels glue; Bazalto (1 pack is enough for 6 panels), Mix (1 pack of glue is sufficient for 6 small or 3 large screens)

Extra charge							
II Price group	III Price group	IV price group					
23,-	52,-	78,-					
23,-	52,-	78,-					

Colour combination - Mix - ceiling and wall screens

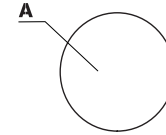
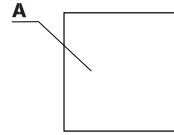

Material	Colour	Screens												
		A - Screen												
Fabric	Nemo	✓												
	Runner	II group ✓												
	Medley	II group ✓												
	**Atlantic	II group ✓												
	Vita	II group ✓												
	Mica	II group ✓												
	Go Check	II group ✓												
	****Charles	II group ✓												
	*Customer's own fabric	II group ✓												
	Synergy	III group ✓												
	***Silvertex	III group ✓												
	Tessa	III group ✓												
	Oceanic	III group ✓												
	Quest	III group ✓												
	Grain	III group ✓												
	Atlas	IV group ✓												



* Employing the customer's fabric requires running upholstery tests in order to check the possibility of realisation.
 ** There is a possibility of ordering the product in full colour spectrum of Atlantic range, as per Gabriel's pattern book, within 8 weeks
 *** There is a possibility of ordering the product in full colour spectrum of Silvertex range, as per Spradling's pattern book, within 15 working days.
 **** There is a possibility of ordering the product in full colour spectrum of Charles range, as per Dekoma pattern book, within the standard delivery time.

Mix - ceiling and wall screens

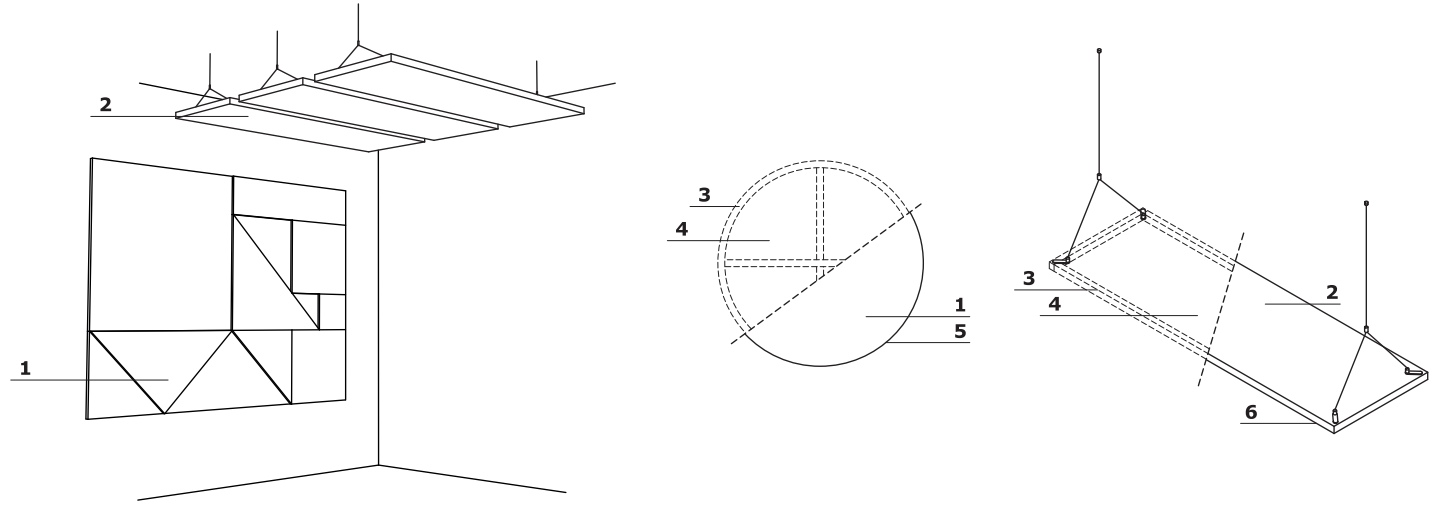

- 1 **Wall screens** - one-side upholstery, Sonic technology structure with A-class acoustics certificate
- 2 **Ceiling screens** - one-side upholstery, Sonic technology structure with A-class acoustics certificate
- 3 **Frame** - chipboard
- 4 **Filling** - acoustic nonwoven with high sound absorption and dispersion properties
- 5 **Fixing element** - glue (1 pack is enough for 6 panels) - order separately (BKL1)
- 6 **Wire cable** - stainless steel, adjustable length up to 200 - 1400 mm







Mix - wall screens														
Symbol	Price EUR	Dimensions			kg m3 pcs	Comments	Extra charge							
		Width	Depth	Height										
MX01P	52,-	600	28	300	1.2 kg 0.008 m3 1 pcs	in the case of choosing MDD installation, it's obligatory to order the glue BKL1	II Price group	III Price group	IV price group					
MX01PG	58,-	600	45	300	1.7 kg 0.012 m3 1 pcs		13,-	26,-	36,-					
MX02P	64,-	900	28	300	1.7 kg 0.012 m3 1 pcs		16,-	34,-	49,-					
MX02PG	72,-	900	45	300	2.4 kg 0.017 m3 1 pcs		16,-	34,-	49,-					
MX03P	76,-	1200	28	300	2.1 kg 0.015 m3 1 pcs		20,-	44,-	62,-					
MX03PG	88,-	1200	45	300	3.2 kg 0.023 m3 1 pcs		20,-	44,-	62,-					
MX08P	172,-	1800	28	600	5.4 kg 0.045 m3 1 pcs		52,-	122,-	174,-					
MX08PG	198,-	1800	45	600	5.5 kg 0.067 m3 1 pcs		52,-	122,-	174,-					
MX09P	214,-	2400	28	600	7.1 kg 0.059 m3 1 pcs		66,-	164,-	234,-					
MX09PG	250,-	2400	45	600	7 kg 0.089 m3 1 pcs		66,-	164,-	234,-					

Mix - wall screens							
	Symbol	Price EUR	Dimensions			kg m3 pcs	Comments
			Width	Depth	Height		
	MX04P	41,-	300	28	300	0.4 kg 0.004 m3 1 pcs	in the case of choosing MDD installation, it's obligatory to order the glue BKL1
	MX04PG	46,-	300	45	300	1 kg 0.006 m3 1 pcs	
	MX05P	72,-	600	28	600	2.2 kg 0.015 m3 1 pcs	
	MX05PG	82,-	600	45	600	3 kg 0.023 m3 1 pcs	
	MX06P	122,-	900	28	900	4.3 kg 0.033 m3 1 pcs	
	MX06PG	144,-	900	45	900	6 kg 0.05 m3 1 pcs	
	MX07P	172,-	1200	28	1200	7.7 kg 0.059 m3 1 pcs	
	MX07PG	202,-	1200	45	1200	9.6 kg 0.089 m3 1 pcs	
	MX10P	98,-	600	28	600	1.7 kg 0.015 m3 1 pcs	in the case of choosing MDD installation, it's obligatory to order the glue BKL1
	MX10PG	102,-	600	45	600	2.3 kg 0.023 m3 1 pcs	
	MX11P	160,-	900	28	900	3.7 kg 0.033 m3 1 pcs	
	MX11PG	182,-	900	45	900	5.1 kg 0.05 m3 1 pcs	
	MX12P	222,-	1200	28	1200	5.9 kg 0.059 m3 1 pcs	
	MX12PG	254,-	1200	45	1200	13.5 kg 0.089 m3 1 pcs	

Extra charge						
II Price group	III Price group	IV price group				
9,-	17,-	23,-				
9,-	17,-	23,-				
13,-	26,-	36,-				
13,-	26,-	36,-				
29,-	72,-	98,-				
29,-	72,-	98,-				
34,-	82,-	122,-				
34,-	82,-	122,-				
13,-	26,-	36,-				
13,-	26,-	36,-				
29,-	72,-	98,-				
29,-	72,-	98,-				
34,-	82,-	122,-				
34,-	82,-	122,-				

Mix - wall screens							
	Symbol	Price EUR	Dimensions			kg m3 pcs	Comments
			Width	Depth	Height		
	MX13P	58,-	600	28	600	1.3 kg 0.015 m3 1 pcs	in the case of choosing MDD installation, it's obligatory to order the glue BKL1
	MX13PG	64,-	600	45	600	1.9 kg 0.023 m3 1 pcs	
	MX14P	98,-	900	28	900	6.2 kg 0.033 m3 1 pcs	
	MX14PG	116,-	900	45	900	2.8 kg 0.05 m3 1 pcs	
	MX15P	140,-	1200	28	1200	8.7 kg 0.059 m3 1 pcs	
	MX15PG	166,-	1200	45	1200	2.2 kg 0.089 m3 1 pcs	
	MX16P	58,-	900	28	450	1.7 kg 0.017 m3 1 pcs	in the case of choosing MDD installation, it's obligatory to order the glue BKL1
	MX16PG	64,-	900	45	450	2.2 kg 0.026 m3 1 pcs	
	MX17P	98,-	1200	28	600	2.5 kg 0.03 m3 1 pcs	
	MX17PG	116,-	1200	45	600	3.5 kg 0.045 m3 1 pcs	

Extra charge						
II Price group	III Price group	IV price group				
13,-	26,-	36,-				
13,-	26,-	36,-				
29,-	72,-	98,-				
29,-	72,-	98,-				
34,-	82,-	122,-				
34,-	82,-	122,-				
16,-	34,-	49,-				
16,-	34,-	49,-				
19,-	41,-	62,-				
19,-	41,-	62,-				

Mix - ceiling screens							
	Symbol	Price EUR	Dimensions			kg m3 pcs	Comments
			Width	Depth	Height		
	MX06S	178,-	900	45	900	4.5 kg 0.05 m3 1 pcs	Product with no installation. Will not be included in general installation costs.
	MX07S	244,-	1200	45	1200	6.4 kg 0.089 m3 1 pcs	Product with no installation. Will not be included in general installation costs.
	MX08S	234,-	1800	45	600	7.4 kg 0.067 m3 1 pcs	Product with no installation. Will not be included in general installation costs.
	MX09S	284,-	2400	45	600	8 kg 0.089 m3 1 pcs	Product with no installation. Will not be included in general installation costs.
	MX11S	210,-	900	45	900	5.5 kg 0.05 m3 1 pcs	Product with no installation. Will not be included in general installation costs.
	MX12S	294,-	1200	45	1200	8.4 kg 0.089 m3 1 pcs	Product with no installation. Will not be included in general installation costs.
	MX14S	144,-	900	45	900	3.8 kg 0.05 m3 1 pcs	Product with no installation. Will not be included in general installation costs.
	MX15S	192,-	1200	45	1200	5.3 kg 0.089 m3 1 pcs	Product with no installation. Will not be included in general installation costs.
Mounting glue							
	BKL1	24,-	220	50	50	0.4 kg 0.001 m3 1 pcs	panels glue; Bazalto (1 pack is enough for 6 panels), Mix (1 pack of glue is sufficient for 6 small or 3 large screens)

Extra charge							
II Price group	III Price group	IV price group					
29,-	72,-	98,-					
34,-	82,-	122,-					
52,-	122,-	174,-					
66,-	164,-	234,-					
29,-	72,-	98,-					
34,-	82,-	122,-					
29,-	72,-	98,-					
34,-	82,-	122,-					

Colour combination - Modesty panels

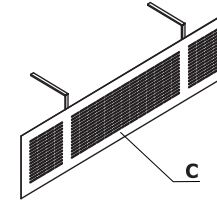
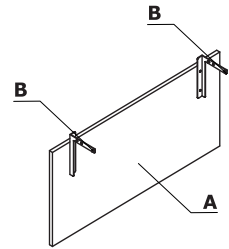

Material	Colour	MFC modesty screens																
		A - MFC modesty panel	B - Bracket - MFC modesty panel	C - Metal modesty panel														
MFC	26 - aluminum satinato	✓																
	31 - canadian oak	✓																
	39 - polar birch	✓																
	64 - cocoa	✓																
	67 - white pastel	✓																
	106 - lowland walnut	✓																
	154 - anthracite	✓																
	08 - black	✓																
	167 - grey oak	✓																
	168 - natural oak	✓																
	169 - honey oak	✓																
	170 - acacia	✓																
	171 - dark walnut	✓																
Metal	M009 - aluminium semi-matt RAL 9006		✓	✓														
	M015 - white semi-matt RAL 9010		✓	✓														
	M115 - black semi-matt RAL 9005		✓	✓														
	M154 - anthracite semi-matt RAL 7043		✓	✓														

Modesty screens

- 1 Modesty panel** - MFC 18 mm, fixings included:
- A. universal bracket
 - B. reinforced bracket - recommended for electric height adjustable desks; mountable only to the edge of the worktop
- 2 Metal modesty panel** - metal, powder coated, fixings included

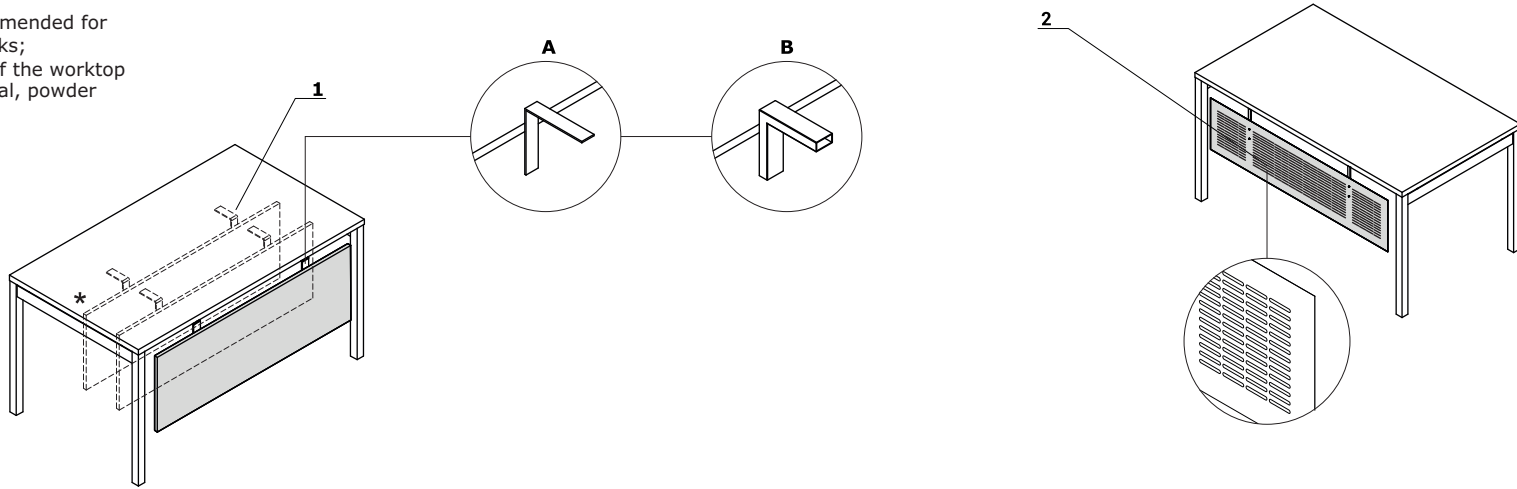

* only the universal bracket allows for mounting the cover at any given place

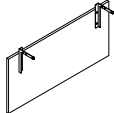
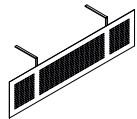
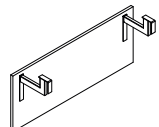



Mfc modesty screens							
	Symbol	Price EUR	Dimensions			kg m3 pcs	Comments
			Width	Depth	Height		
	UM10	88,-	1000	18	400	6.5 kg 0.017 m3 2 pcs	for 1200mm wide desks only
	UM12	92,-	1200	18	400	7.5 kg 0.02 m3 2 pcs	for 1400mm wide desks only
	UM14	98,-	1400	18	400	8.5 kg 0.023 m3 2 pcs	for 1600mm wide desks only
	UM16	102,-	1600	18	400	9.5 kg 0.026 m3 2 pcs	for 1800mm wide desks only
	UM18	108,-	1800	18	400	10.5 kg 0.029 m3 2 pcs	for 2000mm wide desks
	Metal modesty screens						
	UR14	188,-	1200	15	300	2.8 kg 0.008 m3 1 pcs	for 1400mm wide desks, not suitable for Yan
	UR15	192,-	1400	15	300	3.1 kg 0.009 m3 1 pcs	for 1600mm wide desks, not suitable for Yan
	UR16	198,-	1600	15	300	3.5 kg 0.01 m3 1 pcs	for 1800mm wide desks, not suitable for Yan
Modesty panels for sliding top desks							
	UM10S	122,-	1000	18	400	8 kg 0.017 m3 2 pcs	for 1200mm wide desks only
	UM12S	128,-	1200	18	400	8.05 kg 0.019 m3 2 pcs	for 1400mm wide desks onl
	UM14S	132,-	1400	18	400	9.8 kg 0.021 m3 2 pcs	for 1600mm wide desks only
	UM16S	140,-	1600	18	400	10.05 kg 0.023 m3 2 pcs	for 1800mm wide desks only
	UM18S	144,-	1800	18	400	12.3 kg 0.025 m3 2 pcs	for 2000mm wide desks

Extra charge							









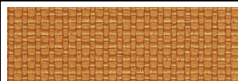

MFC

 08 - black	 26 - aluminum satinato	 31 - canadian oak	 39 - polar birch	 64 - cocoa	 67 - white pastel	 106 - lowland walnut	 154 - anthracite
 167 - grey oak	 168 - natural oak	 169 - honey oak	 170 - acacia	 171 - dark walnut			









Metal

 M009 - aluminium semi-matt RAL 9006	 M015 - white semi-matt RAL 9010	 M115 - black semi-matt RAL 9005	 M154 - anthracite semi-matt RAL 7043
---	---	---	---

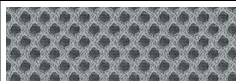



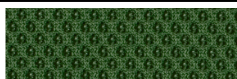

Fabric Nemo - first price group

 NE-1 - beige	 NE-2 - yellow	 NE-3 - orange	 NE-5 - red	 NE-9 - green	 NE-10 - grey	 NE-14 - graphite	 NE-15 - navy blue
 NE-16 - black	 NE-17 - blue						



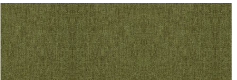

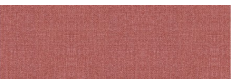

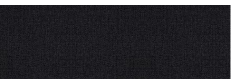

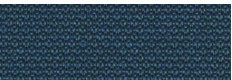

Fabric Runner - second price group

 R-63034 - orange	 R-64089 - red	 R-66063 - blue	 R-60011 - grey	 R-68056 - green	 R-66064 - navy blue	 R-60999 - black	 R-60025 - graphite
 R-61128 - beige	 R-68110 - Dark green						











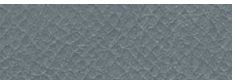

Fabric Medley - second price group

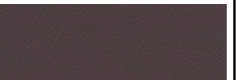
 M-66008 - grey	 M-60003 - light grey	 M-61189 - beige	 M-68005 - dark olive	 M-62002 - yellow	 M-62054 - mustard	 M-63017 - rust-brown	 M-64019 - red
 M-63064 - pink	 M-65011 - grey-violet	 M-66010 - blue	 M-67006 - light blue	 M-60999 - black			

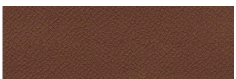



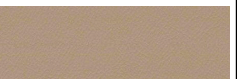





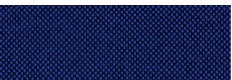



Fabric Atlantic - second price group (Remaining Atlantic colours, as per Gabriel's pattern book, available within 8 weeks)

 A-67043 - dark turquoise	 A-67030 - aquamarine	 A-60141 - light grey	 A-60011 - grey	 A-66064 - navy blue	 A-65037 - violet	 A-62048 - olive	 A-64089 - red
 A-61078 - beige	 A-60025 - graphite						

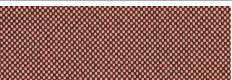
Fabric Vita - second price group

 V-01 - light grey	 V-02 - beige	 V-03 - yellow	 V-04 - grey	 V-07 - dark grey	 V-09 - olive	 V-10 - grey-brown	 V-11 - rust-brown
 V-12 - black	 V-39 - chocolate	 V-18 - aquamarine	 V-19 - blue	 V-29 - dark green	 V-44 - beige	 V-46 - brown	







Fabric Go check - second price group

 G-66136 - blue	 G-66135 - light blue	 G-60080 - dark grey	 G-66138 - navy blue	 G-60084 - dark graphite	 G-68149 - dark green	 G-68152 - green	 G-60079 - grey
 G-64183 - marsala	 G-63079 - orange	 G-64171 - red	 G-64172 - burgundy	 G-61144 - brown	 G-61145 - dark brown		

Fabric Charles - second price group (There is a possibility of ordering the product in full colour spectrum of Charles range, as per Dekoma pattern book, within the standard delivery time.)

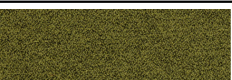
 C-01 - black	 C-05 - grey	 C-06 - beige	 C-14 - brown	 C-18 - rust-brown	 C-21 - red	 C-30 - pink	 C-31 - marsala
 C-32 - dark blue	 C-35 - blue	 C-41 - yellow	 C-44 - olive	 C-45 - green			

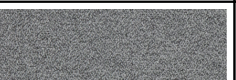
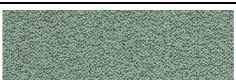
Fabric Mica - second price group

 MC-01 - pink	 MC-02 - red	 MC-03 - dark red	 MC-04 - navy blue	 MC-05 - blue	 MC-06 - aquamarine	 MC-07 - bottle green	 MC-08 - green
 MC-09 - olive	 MC-10 - light olive	 MC-11 - mustard	 MC-12 - yellow	 MC-13 - beige	 MC-14 - light grey	 MC-15 - grey	 MC-16 - graphite
 MC-17 - light blue	 MC-18 - mint	 MC-19 - burgundy					









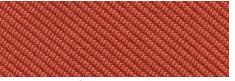

Fabric Synergy - third price group

 LDS08 - grey melange	 LDS20 - light grey	 LDS27 - black	 LDS29 - dark grey	 LDS50 - dark green	 LDS57 - turquoise	 LDS60 - bottle green	 LDS61 - plum
 LDS69 - navy blue	 LDS84 - orange	 LDS86 - red	 LDS88 - aubergine	 LDS19 - beige	 LDS44 - yellow	 LDS79 - brown	

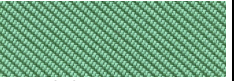





Fabric Tessa - third price group

 T-08 - cream white	 T-09 - beige	 T-05 - grey	 T-03 - dark grey	 T-02 - graphite
---	---	--	--	--

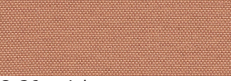
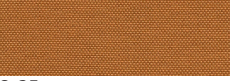
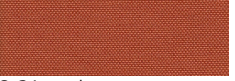
Fabric Oceanic - third price group

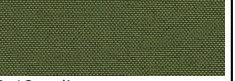
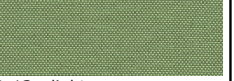









 O-16 - pink	 O-05 - coral	 O-12 - red	 O-07 - yellow	 O-04 - light green	 O-15 - light blue	 O-11 - blue	 O-13 - light grey
 O-08 - dark grey	 O-01 - black						

Fabric Quest - third price group

 Q-26 - pink	 Q-25 - orange	 Q-24 - red	 Q-21 - pastel yellow	 Q-19 - beige	 Q-18 - olive	 Q-13 - light green	 Q-07 - light blue
 Q-08 - navy blue	 Q-04 - graphite						

Fabric Silvertex - third price group - There is a possibility of ordering the product in full colour spectrum of Silvertex range, as per Spradling's pattern book, within 15 working days.

Fabric Grain - third price group

 GR-64249 - pink	 GR-62122 - yellow	 GR-62016 - light orange	 GR-63117 - orange	 GR-68243 - olive	 GR-66236 - sky-blue	 GR-66232 - navy blue	 GR-60301 - grey
 GR-61252 - beige	 GR-61250 - white						

Fabric Atlas - fourth price group

 AS-531 - orange	 AS-501 - pink	 AS-651 - red	 AS-681 - burgundy	 AS-391 - brown	 AS-781 - navy blue	 AS-161 - dark grey	 AS-111 - light grey
 AS-971 - light green	 AS-981 - dark green						

Technical data

Price group	Fabric	Material	Weight	Abrasion resistance rubs	Pilling resistance	Colour fastness to light	Colour fastness to rubbing	Flammability	More information
I	NEMO	Polyester 100%	366g/m2	PN-EN ISO 12947 - 2:2 100,000	Scale 1-8, max 8, PN-EN ISO 105 B02:2013 3-4	Scale 1-5, max 5, PN-EN 1021 - 2:2007, PN-EN 1021 - 1:2007	Scale 1-5, max 5, EN ISO 105x12, (wet/dry) 4-5		
II	RUNNER	Polyester 100%	320g/m2, 510g/lm	70,000 Martindale, BS EN 14465, EN ISO 12947-2	Scale 1-5, max 5, EN ISO 12945-2 4-5	Scale 1-8, max 8, EN ISO 105-B02 5-7	Scale 1-5, max 5, EN ISO 105x12, (wet/dry) 4-5	BS EN 1021-2 Match, BS EN 1021-1 Cigarette, California Bulletin CAL 117-E-Class 1, CA TB 117-2013, Class Uno UNI 9175 Class 1	Acoustic test sound absorption ISO 354
II	MEDLEY	Polyester 100%	364g/m2, 510g/lm	75,000 Martindale	Scale 1-5, max 5, EN ISO 12945-2 4	Scale 1-8, max 8, EN ISO 105-B02 5-7	Scale 1-5, max 5, EN ISO 105x12, (wet/dry) 4-5/4-5	BS EN 1021-2 Match, BS EN 1021-1 Cigarette, California Bulletin CAL 117-E-Class 1, CA TB 117-2013, Class Uno UNI 9175 Class 1	Acoustic test sound absorption: ISO 354
II	ATLANTIC	Polyester 100%	353g/m2, 530g/lm	110,000 Martindale, EN ISO 12947-2)		Scale 1-8, max 8, EN ISO 105-B02 5-7	Scale 1-5, max 5, EN ISO 105x12, (wet/dry) 4-5/4-5	BS EN 1021-2 Match, BS EN 1021-1 Cigarette, ASTM E 84, BS 476 Part 7, Class Uno UNI 9175 Class 1, NF P 92-503 M3P, CA TB 117-2013	
II	VITA	Surface: PVC, 98.5%, PU 1.5% Substrate: Polyester 50%, 50% Cotton	850g/m2, 1190g/lm	100,000 Martindale, EN ISO 5470-2:2003,		Scale 1-8, max 8, EN ISO 105-B02 5-7	Scale 1-5, max 5, EN ISO 105x12, (wet/dry) 4-5/4-5	BS EN 1021-2 Match, BS EN 1021-1 Cigarette, BS 5852:2006 Section 4, Ignition Source 5, BS 7176:2017 Medium Hazard NF P 95 503 M2, FMVSS 302 (ISO 3795)	Flexing cycles: BS EN ISO 7854:1997 Method B, 400,000, Anti-microbial/ Anti-fungal: AATCC 147:2011
II	CHARLES	Polyester 100%	433g/m2	90,000 Martindale, EN ISO 12947-2	Scale 1-5, max 5, EN ISO 12945-2 5	EN ISO 105-B02 5	Scale 1-5, max 5, EN ISO 105-X12, (wet/dry) 4-5	EN1021-2	Thread offset in the seam: EN ISO 13 936-2
II	GO CHECK	Trevira cs 100%	310g/m2	80,000 Martindale, EN ISO 12947-1,2 60,000 Double rubs wyzenbeek (ASTM D4157-07)	Scale 1-5, max 5, EN ISO 12945-2 5	Scale 1-8, max 8, EN ISO 105-B02 5-8	Scale 1-5, max 5, EN ISO 105-X12:2001, (wet/dry) 4-5/4-5	BS EN 1021-1&2 Cigarette and Match, BS 5852:2006 Crib 5, BS 7176:2017 Medium Hazard, NFP 92-503/504/505 M1, Class Uno UNI 9175 Class 1	
II	MICA	97% post-consumer recycled polyester / 3% polyester	218g/m2	60,000 Martindale, EN ISO 12947-2 100,000 Double rubs wyzenbeek (ASTM D4157-07)	Scale 1-5, max 5, EN ISO 12945-2 4-5	Scale 1-8, max 8, EN ISO 105-B02 5-8	Scale 1-5, max 5, EN ISO 105-X12:2001, (wet/dry) 4-5/4-5	BS EN 1021-1 Cigarette, BS EN 1021-2 Match, CA TB 117-2013, ASTM E 84 Class I, BS 476 Part 7 Class I	Acoustic test air flow resistance EN 29053 & ISO 9053-1 (airflow resistance)

Technical data

Price group	Fabric	Material	Weight	Abrasion resistance rubs	Pilling resistance	Colour fastness to light	Colour fastness to rubbing	Flammability	More information
III	SYNERGY	Virgin Wool 95%, Polyamide 5%	400g/m2 560g/lm	100,000 Martindale		ISO 105 B02: 5	Scale 1-5, max 5, EN ISO 105-X12:2001, (wet/dry) 4/4	BS EN 1021-1&2 Cigarette and Match, BS 7176 Low Hazard, UNI 9175 Classe 1 IM, B 3825 & A 3800-1	
III	TESSA	Poliester 95%, Akryl 5%	500g/m2	>75,000 Martindale ISO 12 497-2	Scale 1-5, max 5, EN ISO 12945-2 4-5	ISO 105 B02: 4	Scale 1-5, max 5, EN ISO 105-X12:2001, (wet/dry) 4-5/4-5		Thread offset in the seam: EN ISO 13 936-2
III	OCEANIC	100% post-consumer recycled polyester including 50% Seaqual Yarn	497g/m2	≥100,000 Martindale		5 (ISO 105 - B02), OOC16: 4/5 (ISO 105 - B02)	Scale 1-5, max 5, EN ISO 105-X12:2001, (wet/dry) 4-5/4-5	BS EN 1021-1&2 Cigarette and Match, BS 7176 Low Hazard, BS 5852 Ignition Source 5 with EnviroFlam5, BS 7176 Medium Hazard with EnviroFlam5	
III	QUEST	100% post-consumer recycled polyester including 75% Seaqual Yarn	330g/m2	≥100,000 Martindale		4-6 (ISO 105 - B02)	Scale 1-5, max 5, EN ISO 105-X12:2001, (wet/dry) 4/4	BS EN 1021-1&2 Cigarette and Match, BS 7176 Low Hazard, BS 5852 Ignition Source 5 with EnviroFlam5, BS 7176 Medium Hazard with EnviroFlam5, B 3825 & A 3800-1	
III	GRAIN	2287: 92% post-consumer recycled polyester / 8% polyester 2288: 80% post-consumer recycled polyester / 20% polyeste	439g/m2	100,000 Martindale (EN ISO 12947-2), double rubs wyzenbeek (ASTM D4157-07) (heavy duty upholstery) 100,000	Scale 1-5, max 5, EN ISO 12945-2 5	scale 1-8, max. 8 5-7 (ISO 105 - B02)	Scale 1-5, max 5, EN ISO 105-X12:2001, (wet/dry) 4-5/4-5	BS EN 1021-1&2 Cigarette and Match, CA TB 117-2013	
IV	ATLAS	New wool 90% Nylon 10%	286g/m2 400g/lm	100,000 Martindale EN ISO 12947	EN ISO 12945-2 4-5	ISO 105 B02: 6-7	ISO 105-X12:2001, (wet/dry) 4-5/4-5	BS EN 1021-2 Match, BS EN 1021-1 Cigarette, BS 5 5852 Crib 5, BS 5852 ignition source 3, BS 5852 Part 1, NF D 60 013, UNI 9175 1IM, US Cal, Bull. 117-2013, MED. CertificateIMO	
IV	LEATHER	Leather type - corrected grain leather Type of finishing - pigmented leather		Dry: 500 cycles - min. 4 grey scale Wet: 250 cycles - min. 4 grey scale UNI EN ISO 11640		Light fastness: min. 4 grey scale UNI ISO 105-802		Match flame test: No ignition UNI EN 1021-1-2006 BS EN 1021-1-2006	