

Colour combination - Sonic - ceiling and wall screens

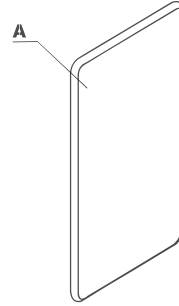

| Material | Colour | Screens | | | | | | | | | | | | | | | |
|----------|------------------------|----------------|--|--|--|--|--|--|--|--|--|--|--|--|--|--|--|
| | | A - Screen | | | | | | | | | | | | | | | |
| Fabric | Nemo | ✓ | | | | | | | | | | | | | | | |
| | Runner | II group ✓ | | | | | | | | | | | | | | | |
| | Medley | II group ✓ | | | | | | | | | | | | | | | |
| | **Atlantic | II group ✓ | | | | | | | | | | | | | | | |
| | Vita | II group ✓ | | | | | | | | | | | | | | | |
| | Mica | II group ✓ | | | | | | | | | | | | | | | |
| | Go Check | II group ✓ | | | | | | | | | | | | | | | |
| | ****Charles | II group ✓ | | | | | | | | | | | | | | | |
| | *Customer's own fabric | II group ✓ | | | | | | | | | | | | | | | |
| | Synergy | III group ✓ | | | | | | | | | | | | | | | |
| | ***Silvertex | III group ✓ | | | | | | | | | | | | | | | |
| | Tessa | III group ✓ | | | | | | | | | | | | | | | |
| | Oceanic | III group ✓ | | | | | | | | | | | | | | | |
| | Quest | III group ✓ | | | | | | | | | | | | | | | |
| | Grain | III group ✓ | | | | | | | | | | | | | | | |
| Atlas | IV group ✓ | | | | | | | | | | | | | | | | |

* Employing the customer's fabric requires running upholstery tests in order to check the possibility of realisation. *** There is a possibility of ordering the product in full colour spectrum of Silvertex range, as per Spradling's pattern book, within 15 working days.

** There is a possibility of ordering the product in full colour spectrum of Atlantic range, as per Gabriel's pattern book, within 8 weeks. **** There is a possibility of ordering the product in full colour spectrum of Charles range, as per Dekoma pattern book, within the standard delivery time.

Sonic - Wall-mounted acoustic screen

- 1 Screen** - one-side upholstery, Sonic technology structure with A-class acoustics certificate, pinnable
- 2 Frame** - glued solid wood structure
- 3 Filling** - acoustic nonwoven with high sound absorption and dispersion properties
- 4 Wall hanger (set includes plugs for solid and plasterboard walls)**

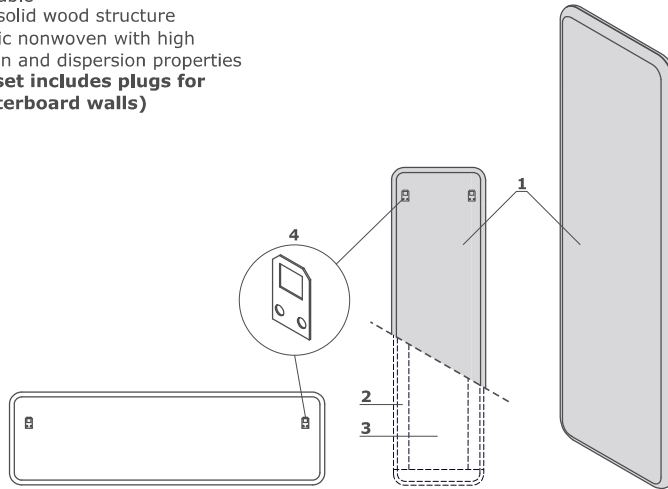

Sonic - ceiling acoustic screen

- 1 Ceiling screens** - one-side upholstery, Sonic technology structure with A-class acoustics certificate
- 2 Wire rope** - stainless steel, adjustable length of screens hanging vertically in the scope of 100 - 900 mm and of screens hanging horizontally in the scope of 200 - 1400 mm.

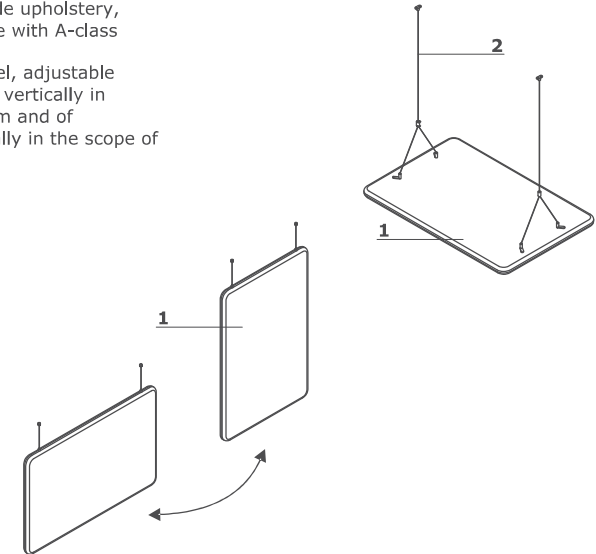

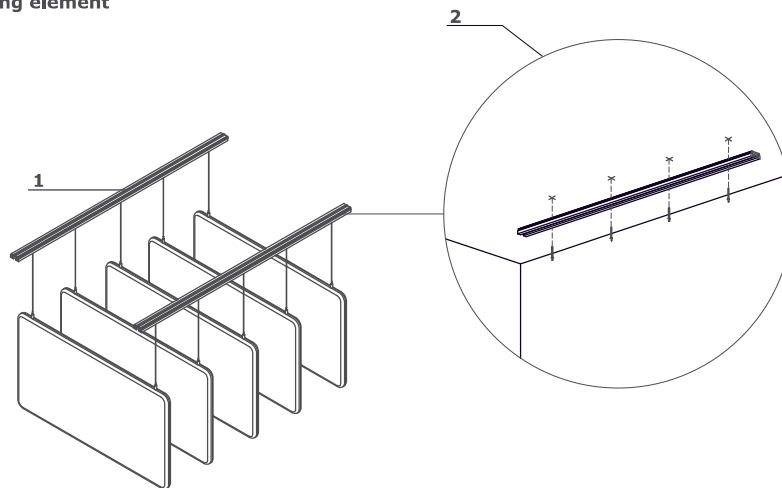

Sonic - ceiling screen – rail for hanging screens

- 1 Joining rail** - aluminium, 2 units
- 2 Fixing element**

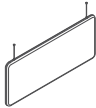

ATTENTION - rawplugs for concrete ceilings with ITB approval – A1 fire resistance.

| Sonic - Wall-mounted acoustic screen | | | | | | | |
|---|--------|-----------|------------|-------|--------|-----------------------------|---|
| | Symbol | Price EUR | Dimensions | | | kg m3 pcs | Comments |
| | | | Width | Depth | Height | | |
|  | ZAK312 | 178,- | 350 | 40 | 1190 | 4 kg 0,023 m3 1 pcs | horizontal and vertical mounting; one-side upholstery |
| | ZAK318 | 210,- | 350 | 40 | 1790 | 6,2 kg 0,034 m3 1 pcs | |
| | ZAK612 | 310,- | 650 | 40 | 1190 | 5,1 kg 0,041 m3 1 pcs | |
| | ZAK618 | 384,- | 650 | 40 | 1790 | 6,9 kg 0,061 m3 1 pcs | |
| Sonic - ceiling screens - fixing to the ceiling with the long edge | | | | | | | |
|  | ZUS12G | 170,- | 1190 | 40 | 350 | 10 kg 0,027 m3 1 pcs | Product with no installation. Will not be included in general installation costs. |
| | ZUS14G | 180,- | 1390 | 40 | 350 | 10 kg 0,031 m3 1 pcs | |
| | ZUS16G | 190,- | 1590 | 40 | 350 | 10 kg 0,036 m3 1 pcs | |
| | ZUS18G | 202,- | 1790 | 40 | 350 | 10 kg 0,04 m3 1 pcs | |
| | ZUS20G | 214,- | 1990 | 40 | 350 | 10 kg 0,045 m3 1 pcs | |
| Sonic - ceiling screens - fixing to the ceiling with the long or short edge | | | | | | | |
|  | ZUS05G | 196,- | 990 | 40 | 500 | 10 kg 0,032 m3 1 pcs | Product with no installation. Will not be included in general installation costs. |
| | ZUS52G | 206,- | 1190 | 40 | 500 | 10 kg 0,038 m3 1 pcs | |
| | ZUS54G | 222,- | 1390 | 40 | 500 | 10 kg 0,044 m3 1 pcs | |
| | ZUS56G | 232,- | 1590 | 40 | 500 | 10 kg 0,05 m3 1 pcs | |
| | ZUS58G | 246,- | 1790 | 40 | 500 | 10 kg 0,056 m3 1 pcs | |
| | ZUS59G | 262,- | 1990 | 40 | 500 | 10 kg 0,063 m3 1 pcs | |

| Extra charge | | | | | | | | | |
|----------------|-----------------|----------------|--|--|--|--|--|--|--|
| II Price group | III Price group | IV price group | | | | | | | |
| 20,- | 44,- | 62,- | | | | | | | |
| 24,- | 56,- | 78,- | | | | | | | |
| 37,- | 88,- | 122,- | | | | | | | |
| 52,- | 122,- | 174,- | | | | | | | |
| 33,- | 78,- | 110,- | | | | | | | |
| 39,- | 92,- | 132,- | | | | | | | |
| 44,- | 102,- | 144,- | | | | | | | |
| 48,- | 122,- | 164,- | | | | | | | |
| 54,- | 132,- | 184,- | | | | | | | |
| 29,- | 66,- | 98,- | | | | | | | |
| 33,- | 78,- | 110,- | | | | | | | |
| 39,- | 92,- | 132,- | | | | | | | |
| 44,- | 102,- | 144,- | | | | | | | |
| 48,- | 122,- | 164,- | | | | | | | |
| 54,- | 132,- | 184,- | | | | | | | |

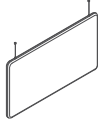
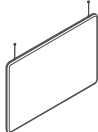
| Sonic - ceiling screens - fixing to the ceiling with the long or short edge | | | | | | | |
|--|----------------|--------------|-------|--------|-----------|----------------------------|---|
| Symbol | Price EUR | Dimensions | | | kg m3 pcs | Comments | |
| | | Width | Depth | Height | | | |
|  | ZPS610G | 228,- | 990 | 40 | 650 | 10 kg 0,041 m3 1 pcs | Product with no installation. Will not be included in general installation costs. |
| | ZPS612G | 240,- | 1190 | 40 | 650 | 10 kg 0,049 m3 1 pcs | |
| | ZPS614G | 254,- | 1390 | 40 | 650 | 10 kg 0,057 m3 1 pcs | |
| | ZPS616G | 266,- | 1590 | 40 | 650 | 10 kg 0,065 m3 1 pcs | |
| | ZPS618G | 278,- | 1790 | 40 | 650 | 10 kg 0,073 m3 1 pcs | |
| | ZPS620G | 294,- | 1990 | 40 | 650 | 10 kg 0,081 m3 1 pcs | |
|  | ZPS810G | 240,- | 990 | 40 | 800 | 10 kg 0,05 m3 1 pcs | Product with no installation. Will not be included in general installation costs. |
| | ZPS812G | 254,- | 1190 | 40 | 800 | 10 kg 0,06 m3 1 pcs | |
| | ZPS814G | 274,- | 1390 | 40 | 800 | 10 kg 0,069 m3 1 pcs | |
| | ZPS816G | 296,- | 1590 | 40 | 800 | 10 kg 0,079 m3 1 pcs | |
| | ZPS818G | 318,- | 1790 | 40 | 800 | 10 kg 0,089 m3 1 pcs | |
| | ZPS820G | 336,- | 1990 | 40 | 800 | 10 kg 0,099 m3 1 pcs | |

| Extra charge | | | | | | |
|----------------|-----------------|----------------|--|--|--|--|
| II Price group | III Price group | IV price group | | | | |
| 29,- | 66,- | 98,- | | | | |
| 33,- | 78,- | 110,- | | | | |
| 39,- | 92,- | 132,- | | | | |
| 44,- | 102,- | 144,- | | | | |
| 48,- | 122,- | 164,- | | | | |
| 54,- | 132,- | 184,- | | | | |
| 58,- | 132,- | 194,- | | | | |
| 66,- | 154,- | 224,- | | | | |
| 78,- | 174,- | 254,- | | | | |
| 88,- | 204,- | 286,- | | | | |
| 98,- | 234,- | 328,- | | | | |
| 102,- | 254,- | 360,- | | | | |

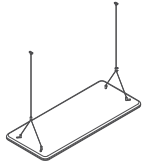
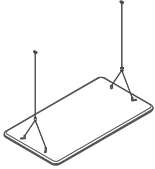
| Sonic - ceiling screens - fixed horizontally | | | | | | | |
|--|-----------------|--------------|-------|--------|-----------|----------------------------|---|
| Symbol | Price EUR | Dimensions | | | kg m3 pcs | Comments | |
| | | Width | Depth | Height | | | |
|  | ZUS05GP | 176,- | 990 | 40 | 500 | 10 kg 0,032 m3 1 pcs | Product with no installation. Will not be included in general installation costs. |
| | ZUS52GP | 188,- | 1190 | 40 | 500 | 10 kg 0,038 m3 1 pcs | |
| | ZUS54GP | 200,- | 1390 | 40 | 500 | 10 kg 0,044 m3 1 pcs | |
| | ZUS56GP | 210,- | 1590 | 40 | 500 | 10 kg 0,05 m3 1 pcs | |
| | ZUS58GP | 222,- | 1790 | 40 | 500 | 10 kg 0,056 m3 1 pcs | |
| | ZUS59GP | 236,- | 1990 | 40 | 500 | 10 kg 0,063 m3 1 pcs | |
|  | ZPS610GP | 204,- | 990 | 40 | 650 | 10 kg 0,041 m3 1 pcs | Product with no installation. Will not be included in general installation costs. |
| | ZPS612GP | 216,- | 1190 | 40 | 650 | 10 kg 0,049 m3 1 pcs | |
| | ZPS614GP | 228,- | 1390 | 40 | 650 | 10 kg 0,057 m3 1 pcs | |
| | ZPS616GP | 240,- | 1590 | 40 | 650 | 10 kg 0,065 m3 1 pcs | |
| | ZPS618GP | 252,- | 1790 | 40 | 650 | 10 kg 0,073 m3 1 pcs | |
| | ZPS620GP | 264,- | 1990 | 40 | 650 | 10 kg 0,081 m3 1 pcs | |

| Extra charge | | | | | | |
|----------------|-----------------|----------------|--|--|--|--|
| II Price group | III Price group | IV price group | | | | |
| 29,- | 66,- | 98,- | | | | |
| 33,- | 78,- | 110,- | | | | |
| 39,- | 92,- | 132,- | | | | |
| 44,- | 102,- | 144,- | | | | |
| 48,- | 122,- | 164,- | | | | |
| 54,- | 132,- | 184,- | | | | |
| 29,- | 66,- | 98,- | | | | |
| 33,- | 78,- | 110,- | | | | |
| 39,- | 92,- | 132,- | | | | |
| 44,- | 102,- | 144,- | | | | |
| 48,- | 122,- | 164,- | | | | |
| 54,- | 132,- | 184,- | | | | |

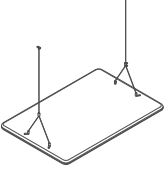
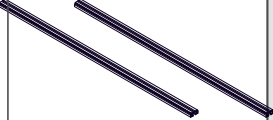
| Sonic - ceiling screens - fixed horizontally | | | | | | | |
|---|--------------|------------|-------|--------|----------------------------|---|--|
| Symbol | Price EUR | Dimensions | | | kg m3 pcs | Comments | |
| | | Width | Depth | Height | | | |
|  ZPS810GP | 216,- | 990 | 40 | 800 | 10 kg 0,05 m3 1 pcs | Product with no installation. Will not be included in general installation costs. | |
| ZPS812GP | 228,- | 1190 | 40 | 800 | 10 kg 0,06 m3 1 pcs | | |
| ZPS814GP | 248,- | 1390 | 40 | 800 | 10 kg 0,069 m3 1 pcs | | |
| ZPS816GP | 266,- | 1590 | 40 | 800 | 10 kg 0,079 m3 1 pcs | | |
| ZPS818GP | 286,- | 1790 | 40 | 800 | 10 kg 0,089 m3 1 pcs | | |
| ZPS820GP | 302,- | 1990 | 40 | 800 | 10 kg 0,099 m3 1 pcs | | |
| Accessories | | | | | | | |
|  ZSZ200 | 0,- | 2000 | 30 | 30 | 0 kg 0 m3 0 pcs | rail for hanging ceiling screen (2 pcs) | |

| Extra charge | | | | | | | | | |
|----------------|-----------------|----------------|--|--|--|--|--|--|--|
| II Price group | III Price group | IV price group | | | | | | | |
| 58,- | 132,- | 194,- | | | | | | | |
| 66,- | 154,- | 224,- | | | | | | | |
| 78,- | 174,- | 254,- | | | | | | | |
| 88,- | 204,- | 286,- | | | | | | | |
| 98,- | 234,- | 328,- | | | | | | | |
| 102,- | 254,- | 360,- | | | | | | | |
| | | | | | | | | | |
| | | | | | | | | | |

Colour combination - Bazalto - wall screens

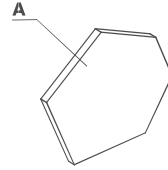

| Material | Colour | Screens | | | | | | | | | | | | | | | | |
|----------|------------------------|----------------|--|--|--|--|--|--|--|--|--|--|--|--|--|--|--|--|
| | | A - Screen | | | | | | | | | | | | | | | | |
| Fabric | Nemo | ✓ | | | | | | | | | | | | | | | | |
| | Runner | II group ✓ | | | | | | | | | | | | | | | | |
| | Medley | II group ✓ | | | | | | | | | | | | | | | | |
| | **Atlantic | II group ✓ | | | | | | | | | | | | | | | | |
| | Vita | II group ✓ | | | | | | | | | | | | | | | | |
| | Mica | II group ✓ | | | | | | | | | | | | | | | | |
| | Go Check | II group ✓ | | | | | | | | | | | | | | | | |
| | ****Charles | II group ✓ | | | | | | | | | | | | | | | | |
| | Synergy | III group ✓ | | | | | | | | | | | | | | | | |
| | ***Silvertex | III group ✓ | | | | | | | | | | | | | | | | |
| | Tessa | III group ✓ | | | | | | | | | | | | | | | | |
| | Oceanic | III group ✓ | | | | | | | | | | | | | | | | |
| | Quest | III group ✓ | | | | | | | | | | | | | | | | |
| | Grain | III group ✓ | | | | | | | | | | | | | | | | |
| | *Customer's own fabric | II group ✓ | | | | | | | | | | | | | | | | |
| | Atlas | IV group ✓ | | | | | | | | | | | | | | | | |

* Employing the customer's fabric requires running upholstery tests in order to check the possibility of realisation.

** There is a possibility of ordering the product in full colour spectrum of Atlantic range, as per Gabriel's pattern book, within 8 weeks

*** There is a possibility of ordering the product in full colour spectrum of Silvertex range, as per Spradling's pattern book, within 15 working days.

**** There is a possibility of ordering the product in full colour spectrum of Charles range, as per Dekoma pattern book, within the standard delivery time.

Bazalto - Wall-mounted screen

- Screen** - one-side upholstery, Sonic technology structure with A-class acoustics certificate, pinnable
- Frame** - chipboard
- Filling** - acoustic nonwoven with high sound absorption and dispersion properties
- Fixing element** - glue (1 pack is enough for 6 panels) - order separately (BKL1)

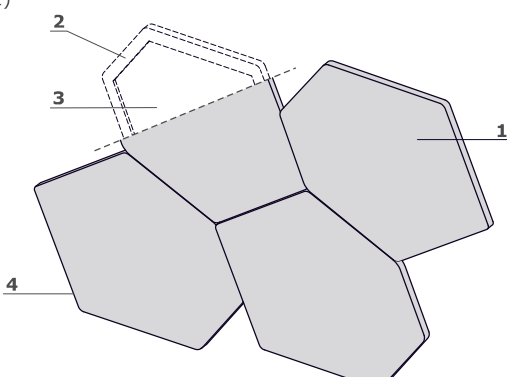

| Bazalto - Wall-mounted screen | | | | | | | |
|---|-------------|-------------|------------|-------|--------|-----------------------------|---|
| | Symbol | Price EUR | Dimensions | | | kg m3 pcs | Comments |
| | | | Width | Depth | Height | | |
|  | BWP1 | 72,- | 650 | 21 | 550 | 1.7 kg 0,01 m3 1 pcs | in the case of choosing MDD installation, it's obligatory to order the glue BKL1 |
| | BWP2 | 88,- | 650 | 39 | 550 | 2.3 kg 0,019 m3 1 pcs | |
| Mounting glue | | | | | | | |
| | BKL1 | 24,- | 220 | 50 | 50 | 0.4 kg 0,001 m3 1 pcs | panels glue; Bazalto (1 pack is enough for 6 panels), Mix (1 pack of glue is sufficient for 6 small or 3 large screens) |

| Extra charge | | | | | | | | | |
|----------------|-----------------|----------------|--|--|--|--|--|--|--|
| II Price group | III Price group | IV price group | | | | | | | |
| 23,- | 52,- | 78,- | | | | | | | |
| 23,- | 52,- | 78,- | | | | | | | |
| | | | | | | | | | |

Colour combination - Mix - ceiling and wall screens

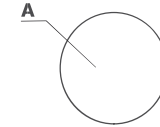
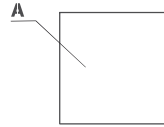

| Material | Colour | Screens | | | | | | | | | | | | | |
|----------|------------------------|-------------|--|--|--|--|--|--|--|--|--|--|--|--|--|
| | | A - Screen | | | | | | | | | | | | | |
| Fabric | Nemo | ✓ | | | | | | | | | | | | | |
| | Runner | II group ✓ | | | | | | | | | | | | | |
| | Medley | II group ✓ | | | | | | | | | | | | | |
| | **Atlantic | II group ✓ | | | | | | | | | | | | | |
| | Vita | II group ✓ | | | | | | | | | | | | | |
| | Mica | II group ✓ | | | | | | | | | | | | | |
| | Go Check | II group ✓ | | | | | | | | | | | | | |
| | ****Charles | II group ✓ | | | | | | | | | | | | | |
| | *Customer's own fabric | II group ✓ | | | | | | | | | | | | | |
| | Synergy | III group ✓ | | | | | | | | | | | | | |
| | ***Silvertex | III group ✓ | | | | | | | | | | | | | |
| | Tessa | III group ✓ | | | | | | | | | | | | | |
| | Oceanic | III group ✓ | | | | | | | | | | | | | |
| | Quest | III group ✓ | | | | | | | | | | | | | |
| | Grain | III group ✓ | | | | | | | | | | | | | |
| | Atlas | IV group ✓ | | | | | | | | | | | | | |

* Employing the customer's fabric requires running upholstery tests in order to check the possibility of realisation.

** There is a possibility of ordering the product in full colour spectrum of Atlantic range, as per Gabriel's pattern book, within 8 weeks

*** There is a possibility of ordering the product in full colour spectrum of Silvertex range, as per Spradling's pattern book, within 15 working days.

**** There is a possibility of ordering the product in full colour spectrum of Charles range, as per Dekoma pattern book, within the standard delivery time.

Mix - ceiling and wall screens

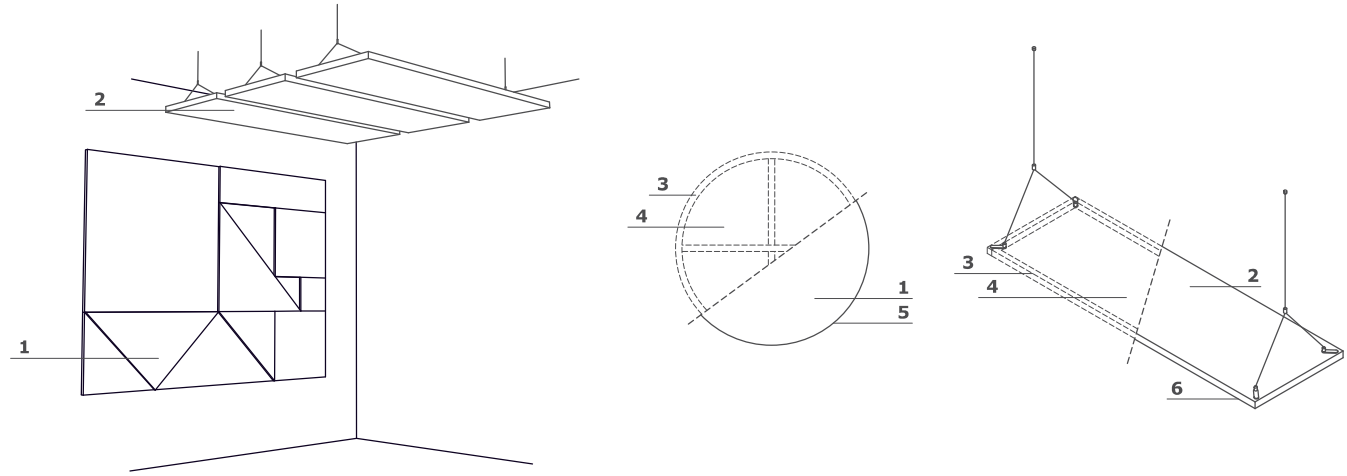

- 1 **Wall screens** - one-side upholstery, Sonic technology structure with A-class acoustics certificate
- 2 **Ceiling screens** - one-side upholstery, Sonic technology structure with A-class acoustics certificate
- 3 **Frame** - chipboard
- 4 **Filling** - acoustic nonwoven with high sound absorption and dispersion properties
- 5 **Fixing element** - glue (1 pack is enough for 6 panels) - order separately (BKL1)
- 6 **Wire cable** - stainless steel, adjustable length up to 200 - 1400 mm





| Mix - wall screens | | | | | | |
|--------------------|--------------|------------|-------|--------|-----------------------------|--|
| Symbol | Price EUR | Dimensions | | | kg m3 pcs | Comments |
| | | Width | Depth | Height | | |
| MX01P | 52,- | 600 | 28 | 300 | 1.2 kg 0.008 m3 1 pcs | in the case of choosing MDD installation, it's obligatory to order the glue BKL1 |
| MX01PG | 58,- | 600 | 45 | 300 | 1.7 kg 0.012 m3 1 pcs | |
| MX02P | 64,- | 900 | 28 | 300 | 1.7 kg 0.012 m3 1 pcs | |
| MX02PG | 72,- | 900 | 45 | 300 | 2.4 kg 0.017 m3 1 pcs | |
| MX03P | 76,- | 1200 | 28 | 300 | 2.1 kg 0.015 m3 1 pcs | |
| MX03PG | 88,- | 1200 | 45 | 300 | 3.2 kg 0.023 m3 1 pcs | |
| MX08P | 172,- | 1800 | 28 | 600 | 5.4 kg 0.045 m3 1 pcs | |
| MX08PG | 198,- | 1800 | 45 | 600 | 5.5 kg 0.067 m3 1 pcs | |
| MX09P | 214,- | 2400 | 28 | 600 | 7.1 kg 0.059 m3 1 pcs | |
| MX09PG | 250,- | 2400 | 45 | 600 | 7 kg 0.089 m3 1 pcs | |







| Extra charge | | | | | | |
|----------------|-----------------|----------------|--|--|--|--|
| II Price group | III Price group | IV price group | | | | |
| 13,- | 26,- | 36,- | | | | |
| 13,- | 26,- | 36,- | | | | |
| 16,- | 34,- | 49,- | | | | |
| 16,- | 34,- | 49,- | | | | |
| 20,- | 44,- | 62,- | | | | |
| 20,- | 44,- | 62,- | | | | |
| 52,- | 122,- | 174,- | | | | |
| 52,- | 122,- | 174,- | | | | |
| 66,- | 164,- | 234,- | | | | |
| 66,- | 164,- | 234,- | | | | |

| Mix - wall screens | | | | | | |
|--|--------------|------------|-------|--------|------------------------------|--|
| Symbol | Price EUR | Dimensions | | | kg m3 pcs | Comments |
| | | Width | Depth | Height | | |
|  MX04P | 41,- | 300 | 28 | 300 | 0,4 kg 0,004 m3 1 pcs | in the case of choosing MDD installation, it's obligatory to order the glue BKL1 |
| MX04PG | 46,- | 300 | 45 | 300 | 1 kg 0,006 m3 1 pcs | |
| MX05P | 72,- | 600 | 28 | 600 | 2,2 kg 0,015 m3 1 pcs | |
| MX05PG | 82,- | 600 | 45 | 600 | 3 kg 0,023 m3 1 pcs | |
| MX06P | 122,- | 900 | 28 | 900 | 4,3 kg 0,033 m3 1 pcs | |
| MX06PG | 144,- | 900 | 45 | 900 | 6 kg 0,05 m3 1 pcs | |
| MX07P | 172,- | 1200 | 28 | 1200 | 7,7 kg 0,059 m3 1 pcs | |
| MX07PG | 202,- | 1200 | 45 | 1200 | 9,6 kg 0,089 m3 1 pcs | |
|  MX10P | 98,- | 600 | 28 | 600 | 1,7 kg 0,015 m3 1 pcs | in the case of choosing MDD installation, it's obligatory to order the glue BKL1 |
| MX10PG | 102,- | 600 | 45 | 600 | 2,3 kg 0,023 m3 1 pcs | |
| MX11P | 160,- | 900 | 28 | 900 | 3,7 kg 0,033 m3 1 pcs | |
| MX11PG | 182,- | 900 | 45 | 900 | 5,1 kg 0,05 m3 1 pcs | |
| MX12P | 222,- | 1200 | 28 | 1200 | 5,9 kg 0,059 m3 1 pcs | |
| MX12PG | 254,- | 1200 | 45 | 1200 | 13,5 kg 0,089 m3 1 pcs | |

| Extra charge | | | | | | |
|----------------|-----------------|----------------|--|--|--|--|
| II Price group | III Price group | IV price group | | | | |
| 9,- | 17,- | 23,- | | | | |
| 9,- | 17,- | 23,- | | | | |
| 13,- | 26,- | 36,- | | | | |
| 13,- | 26,- | 36,- | | | | |
| 29,- | 72,- | 98,- | | | | |
| 29,- | 72,- | 98,- | | | | |
| 34,- | 82,- | 122,- | | | | |
| 34,- | 82,- | 122,- | | | | |
| 13,- | 26,- | 36,- | | | | |
| 13,- | 26,- | 36,- | | | | |
| 29,- | 72,- | 98,- | | | | |
| 29,- | 72,- | 98,- | | | | |
| 34,- | 82,- | 122,- | | | | |
| 34,- | 82,- | 122,- | | | | |

| Mix - wall screens | | | | | | | |
|---|---------------|--------------|-------|--------|-----------|-----------------------------|--|
| Symbol | Price EUR | Dimensions | | | kg m3 pcs | Comments | |
| | | Width | Depth | Height | | | |
|  | MX13P | 58,- | 600 | 28 | 600 | 1.3 kg 0.015 m3 1 pcs | in the case of choosing MDD installation, it's obligatory to order the glue BKL1 |
| | MX13PG | 64,- | 600 | 45 | 600 | 1.9 kg 0.023 m3 1 pcs | |
| | MX14P | 98,- | 900 | 28 | 900 | 6.2 kg 0.033 m3 1 pcs | |
| | MX14PG | 116,- | 900 | 45 | 900 | 2.8 kg 0.05 m3 1 pcs | |
| | MX15P | 140,- | 1200 | 28 | 1200 | 8.7 kg 0.059 m3 1 pcs | |
| | MX15PG | 166,- | 1200 | 45 | 1200 | 2.2 kg 0.089 m3 1 pcs | |
|  | MX16P | 58,- | 900 | 28 | 450 | 1.7 kg 0.017 m3 1 pcs | in the case of choosing MDD installation, it's obligatory to order the glue BKL1 |
| | MX16PG | 64,- | 900 | 45 | 450 | 2.2 kg 0.026 m3 1 pcs | |
| | MX17P | 98,- | 1200 | 28 | 600 | 2.5 kg 0.03 m3 1 pcs | |
| | MX17PG | 116,- | 1200 | 45 | 600 | 3.5 kg 0.045 m3 1 pcs | |

| Extra charge | | | | | | |
|----------------|-----------------|----------------|--|--|--|--|
| II Price group | III Price group | IV price group | | | | |
| 13,- | 26,- | 36,- | | | | |
| 13,- | 26,- | 36,- | | | | |
| 29,- | 72,- | 98,- | | | | |
| 29,- | 72,- | 98,- | | | | |
| 34,- | 82,- | 122,- | | | | |
| 34,- | 82,- | 122,- | | | | |
| 16,- | 34,- | 49,- | | | | |
| 16,- | 34,- | 49,- | | | | |
| 19,- | 41,- | 62,- | | | | |
| 19,- | 41,- | 62,- | | | | |





| Mix - ceiling screens | | | | | | | |
|---|--------------|--------------|------------|-------|--------|-----------------------------|---|
| | Symbol | Price EUR | Dimensions | | | kg m3 pcs | Comments |
| | | | Width | Depth | Height | | |
|  | MX06S | 178,- | 900 | 45 | 900 | 4,5 kg 0,05 m3 1 pcs | Product with no installation. Will not be included in general installation costs. |
| | MX07S | 244,- | 1200 | 45 | 1200 | 6,4 kg 0,089 m3 1 pcs | Product with no installation. Will not be included in general installation costs. |
|  | MX08S | 234,- | 1800 | 45 | 600 | 7,4 kg 0,067 m3 1 pcs | Product with no installation. Will not be included in general installation costs. |
| | MX09S | 284,- | 2400 | 45 | 600 | 8 kg 0,089 m3 1 pcs | Product with no installation. Will not be included in general installation costs. |
|  | MX11S | 210,- | 900 | 45 | 900 | 5,5 kg 0,05 m3 1 pcs | Product with no installation. Will not be included in general installation costs. |
| | MX12S | 294,- | 1200 | 45 | 1200 | 8,4 kg 0,089 m3 1 pcs | Product with no installation. Will not be included in general installation costs. |
|  | MX14S | 144,- | 900 | 45 | 900 | 3,8 kg 0,05 m3 1 pcs | Product with no installation. Will not be included in general installation costs. |
| | MX15S | 192,- | 1200 | 45 | 1200 | 5,3 kg 0,089 m3 1 pcs | Product with no installation. Will not be included in general installation costs. |
| Mounting glue | | | | | | | |
| | BKL1 | 24,- | 220 | 50 | 50 | 0,4 kg 0,001 m3 1 pcs | panels glue; Bazalto (1 pack is enough for 6 panels), Mix (1 pack of glue is sufficient for 6 small or 3 large screens) |

| Extra charge | | | | | | | | | |
|----------------|-----------------|----------------|--|--|--|--|--|--|--|
| II Price group | III Price group | IV price group | | | | | | | |
| 29,- | 72,- | 98,- | | | | | | | |
| 34,- | 82,- | 122,- | | | | | | | |
| 52,- | 122,- | 174,- | | | | | | | |
| 66,- | 164,- | 234,- | | | | | | | |
| 29,- | 72,- | 98,- | | | | | | | |
| 34,- | 82,- | 122,- | | | | | | | |
| 29,- | 72,- | 98,- | | | | | | | |
| 34,- | 82,- | 122,- | | | | | | | |
| | | | | | | | | | |
| | | | | | | | | | |











MFC

| | | | | | | | |
|---|---|--|--|--|--|---|---|
|  08 - black |  26 - aluminum satinato |  31 - canadian oak |  39 - polar birch |  64 - cocoa |  67 - white pastel |  106 - lowland walnut |  154 - anthracite |
|  167 - grey oak |  168 - natural oak |  169 - honey oak |  170 - acacia |  171 - dark walnut | | | |









Metal

| | | | |
|---|---|---|---|
|  M009 - aluminium semi-matt RAL 9006 |  M015 - white semi-matt RAL 9010 |  M115 - black semi-matt RAL 9005 |  M154 - anthracite semi-matt RAL 7043 |
|---|---|---|---|

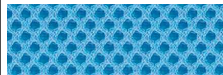
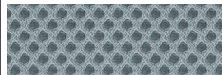
Fabric Nemo - first price group

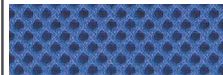
| | | | | | | | |
|--|--|--|--|---|---|---|--|
|  NE-1 - beige |  NE-2 - yellow |  NE-3 - orange |  NE-5 - red |  NE-9 - green |  NE-10 - grey |  NE-14 - graphite |  NE-15 - navy blue |
|  NE-16 - black |  NE-17 - blue | | | | | | |











Fabric Runner - second price group

| | | | | | | | |
|---|---|---|--|--|--|--|---|
|  R-63034 - orange |  R-64089 - red |  R-66063 - blue |  R-60011 - grey |  R-68056 - green |  R-66064 - navy blue |  R-60999 - black |  R-60025 - graphite |
|  R-61128 - beige |  R-68110 - Dark green | | | | | | |







Fabric Medley - second price group

| | | | | | | | |
|---|--|--|--|---|--|---|--|
|  M-66008 - grey |  M-60003 - light grey |  M-61189 - beige |  M-68005 - dark olive |  M-62002 - yellow |  M-62054 - mustard |  M-63017 - rust-brown |  M-64019 - red |
|  M-63064 - pink |  M-65011 - grey-violet |  M-66010 - blue |  M-67006 - light blue |  M-60999 - black | | | |



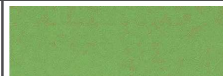
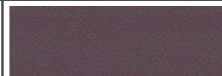
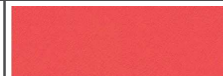
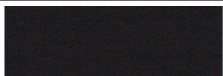
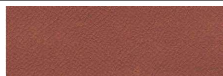

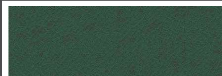

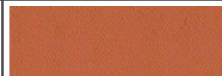



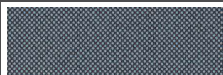

Fabric Atlantic - second price group (Remaining Atlantic colours, as per Gabriel's pattern book, available within 8 weeks)

| | | | | | | | |
|---|---|---|--|--|---|--|--|
|  A-67043 - dark turquoise |  A-67030 - aquamarine |  A-60141 - light grey |  A-60011 - grey |  A-66064 - navy blue |  A-65037 - violet |  A-62048 - olive |  A-64089 - red |
|  A-61078 - beige |  A-60025 - graphite | | | | | | |

Fabric Vita - second price group

| | | | | | | | |
|--|--|---|--|---|--|--|--|
|  V-01 - light grey |  V-02 - beige |  V-03 - yellow |  V-04 - grey |  V-07 - dark grey |  V-09 - olive |  V-10 - grey-brown |  V-11 - rust-brown |
|  V-12 - black |  V-39 - chocolate |  V-18 - aquamarine |  V-19 - blue |  V-29 - dark green |  V-44 - beige |  V-46 - brown | |



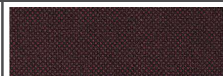







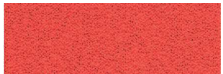

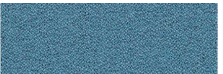
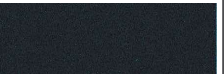
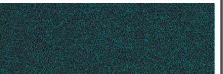
Fabric Go check - second price group

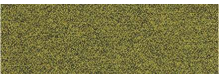
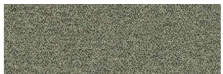
| | | | | | | | |
|--|---|--|---|--|---|--|---|
|  G-66136 - blue |  G-66135 - light blue |  G-60080 - dark grey |  G-66138 - navy blue |  G-60084 - dark graphite |  G-68149 - dark green |  G-68152 - green |  G-60079 - grey |
|  G-64183 - marsala |  G-63079 - orange |  G-64171 - red |  G-64172 - burgundy |  G-61144 - brown |  G-61145 - dark brown | | |

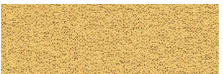

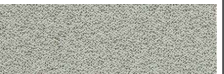

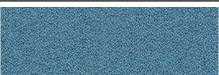
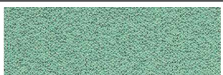





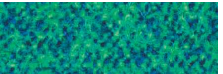
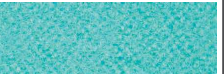
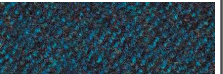

Fabric Charles - second price group (There is a possibility of ordering the product in full colour spectrum of Charles range, as per Dekoma pattern book, within the standard delivery time.)

| | | | | | | | |
|---|--|--|--|--|---|--|---|
|  C-01 - black |  C-05 - grey |  C-06 - beige |  C-14 - brown |  C-18 - rust-brown |  C-21 - red |  C-30 - pink |  C-31 - marsala |
|  C-32 - dark blue |  C-35 - blue |  C-41 - yellow |  C-44 - olive |  C-45 - green | | | |

Fabric Mica - second price group

| | | | | | | | |
|---|--|---|---|--|---|---|---|
|  MC-01 - pink |  MC-02 - red |  MC-03 - dark red |  MC-04 - navy blue |  MC-05 - blue |  MC-06 - aquamarine |  MC-07 - bottle green |  MC-08 - green |
|  MC-09 - olive |  MC-10 - light olive |  MC-11 - mustard |  MC-12 - yellow |  MC-13 - beige |  MC-14 - light grey |  MC-15 - grey |  MC-16 - graphite |
|  MC-17 - light blue |  MC-18 - mint |  MC-19 - burgundy | | | | | |

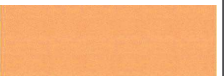









Fabric Synergy - third price group

| | | | | | | | |
|--|--|---|---|--|---|--|--|
|  LDS08 - grey melange |  LDS20 - light grey |  LDS27 - black |  LDS29 - dark grey |  LDS50 - dark green |  LDS57 - turquoise |  LDS60 - bottle green |  LDS61 - plum |
|  LDS69 - navy blue |  LDS84 - orange |  LDS86 - red |  LDS88 - aubergine |  LDS19 - beige |  LDS44 - yellow |  LDS79 - brown | |









Fabric Tessa - third price group

| | | | | |
|---|---|--|--|--|
|  T-08 - cream white |  T-09 - beige |  T-05 - grey |  T-03 - dark grey |  T-02 - graphite |
|---|---|--|--|--|

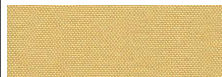
Fabric Oceanic - third price group









| | | | | | | | |
|---|---|---|---|---|--|--|--|
|  O-16 - pink |  O-05 - coral |  O-12 - red |  O-07 - yellow |  O-04 - light green |  O-15 - light blue |  O-11 - blue |  O-13 - light grey |
|  O-08 - dark grey |  O-01 - black | | | | | | |

Fabric Quest - third price group

| | | | | | | | |
|---|--|---|--|---|---|---|--|
|  Q-26 - pink |  Q-25 - orange |  Q-24 - red |  Q-21 - pastel yellow |  Q-19 - beige |  Q-18 - olive |  Q-13 - light green |  Q-07 - light blue |
|  Q-08 - navy blue |  Q-04 - graphite | | | | | | |

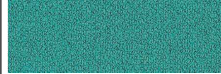
Fabric Silvertex - third price group - There is a possibility of ordering the product in full colour spectrum of Silvertex range, as per Spradling's pattern book, within 15 working days.

Fabric Grain - third price group

| | | | | | | | |
|---|--|--|---|---|--|---|--|
|  GR-64249 - pink |  GR-62122 - yellow |  GR-62016 - light orange |  GR-63117 - orange |  GR-68243 - olive |  GR-66236 - sky-blue |  GR-66232 - navy blue |  GR-60301 - grey |
|  GR-61252 - beige |  GR-61250 - white | | | | | | |

Fabric Atlas - fourth price group

| | | | | | | | |
|---|--|---|---|---|---|---|--|
|  AS-531 - orange |  AS-501 - pink |  AS-651 - red |  AS-681 - burgundy |  AS-391 - brown |  AS-781 - navy blue |  AS-161 - dark grey |  AS-111 - light grey |
|  AS-971 - light green |  AS-981 - dark green | | | | | | |

Technical data

| Price group | Fabric | Material | Weight | Abrasion resistance rubs | Pilling resistance | Colour fastness to light | Colour fastness to rubbing | Flammability | More information |
|-------------|-----------------|--|---------------------|--|--|--|--|--|--|
| I | NEMO | Polyester 100% | 366g/m2 | PN-EN ISO 12947 - 2:2 100,000 | Scale 1-8, max 8, PN-EN ISO 105 B02:2013 3-4 | Scale 1-5, max 5, PN-EN 1021 - 2:2007, PN-EN 1021 - 1:2007 | Scale 1-5, max 5, EN ISO 105x12, (wet/dry) 4-5 | | |
| II | RUNNER | Polyester 100% | 320g/m2 510g/lm | 70,000 Martindale, BS EN 14465, EN ISO 12947-2 | Scale 1-5, max 5, EN ISO 12945-2 4-5 | Scale 1-8, max 8, EN ISO 105-B02 5-7 | Scale 1-5, max 5, EN ISO 105x12, (wet/dry) 4-5 | BS EN 1021-2 Match, BS EN 1021-1 Cigarette, California Bulletin CAL 117-E-Class 1, CA TB 117-2013, Class Uno UNI 9175 Class 1 | Acoustic test sound absorption ISO 354 |
| II | MEDLEY | Polyester 100% | 364g/m2 510g/lm | 75,000 Martindale | Scale 1-5, max 5, EN ISO 12945-2 4 | Scale 1-8, max 8, EN ISO 105-B02 5-7 | Scale 1-5, max 5, EN ISO 105x12, (wet/dry) 4-5/4-5 | BS EN 1021-2 Match, BS EN 1021-1 Cigarette, California Bulletin CAL 117-E-Class 1, CA TB 117-2013, Class Uno UNI 9175 Class 1 | Acoustic test sound absorption: ISO 354 |
| II | ATLANTIC | Polyester 100% | 353g/m2 530g/lm | 110,000 Martindale, EN ISO 12947-2) | | Scale 1-8, max 8, EN ISO 105-B02 5-7 | Scale 1-5, max 5, EN ISO 105x12, (wet/dry) 4-5/4-5 | BS EN 1021-2 Match, BS EN 1021-1 Cigarette, ASTM E 84, BS 476 Part 7, Class Uno UNI 9175 Class 1, NF P 92-503 M3P, CA TB 117-2013 | |
| II | VITA | Surface: PVC, 98,5%, PU 1,5% Substrate: Polyester 50%, 50% Cotton | 850g/m2 1190g/lm | 100,000 Martindale, EN ISO 5470-2:2003, | | Scale 1-8, max 8, EN ISO 105-B02 5-7 | Scale 1-5, max 5, EN ISO 105x12, (wet/dry) 4-5/4-5 | BS EN 1021-2 Match, BS EN 1021-1 Cigarette, BS 5852:2006 Section 4, Ignition Source 5, BS 7176:2017 Medium Hazard NF P 95 503 M2, FMVSS 302 (ISO 3795) | Flexing cycles: BS EN ISO 7854:1997 Method B, 400,000, Anti-microbial/ Anti-fungal: AATCC 147:2011 |
| II | CHARLES | Polyester 100% | 433g/m2 | 90,000 Martindale, EN ISO 12947-2 | Scale 1-5, max 5, EN ISO 12945-2 5 | EN ISO 105-B02 5 | Scale 1-5, max 5, EN ISO 105-X12, (wet/dry) 4-5 | EN1021-2 | Thread offset in the seam: EN ISO 13 936-2 |
| II | GO CHECK | Trevira cs 100% | 310g/m2 | 80,000 Martindale, EN ISO 12947-1,2 60,000 Double rubs wyzenbeek (ASTM D4157-07) | Scale 1-5, max 5, EN ISO 12945-2 5 | Scale 1-8, max 8, EN ISO 105-B02 5-8 | Scale 1-5, max 5, EN ISO 105-X12:2001, (wet/dry) 4-5/4-5 | BS EN 1021-1&2 Cigarette and Match, BS 5852:2006 Crib 5, BS 7176:2017 Medium Hazard, NF P 92-503/504/505 M1, Class Uno UNI 9175 Class 1 | |
| II | MICA | 97% post-consumer recycled polyester / 3% polyester | 218g/m2 | 60,000 Martindale, EN ISO 12947-2 100,000 Double rubs wyzenbeek (ASTM D4157-07) | Scale 1-5, max 5, EN ISO 12945-2 4-5 | Scale 1-8, max 8, EN ISO 105-B02 5-8 | Scale 1-5, max 5, EN ISO 105-X12:2001, (wet/dry) 4-5/4-5 | BS EN 1021-1 Cigarette, BS EN 1021-2 Match, CA TB 117-2013, ASTM E 84 Class I, BS 476 Part 7 Class I | Acoustic test air flow resistanc EN 29053 & ISO 9053-1 (airflow resistance) |

Technical data

| Price group | Fabric | Material | Weight | Abrasion resistance rubs | Pilling resistance | Colour fastness to light | Colour fastness to rubbing | Flammability | More information |
|-------------|----------------|--|--------------------|--|--------------------------------------|--|--|---|---|
| III | SYNERGY | Virgin Wool 95%, Polyamide 5% | 400g/m2 560g/lm | 100,000 Martindale | | ISO 105 B02: 5 | Scale 1-5, max 5, EN ISO 105-X12:2001, (wet/dry) 4/4 | BS EN 1021-1&2 Cigarette and Match, BS 7176 Low Hazard, UNI 9175 Classe 1 IM, B 3825 & A 3800-1 | |
| III | TESSA | Poliester 95%, Akryl 5% | 500g/m2 | >75,000 Martindale ISO 12 497-2 | Scale 1-5, max 5, EN ISO 12945-2 4-5 | ISO 105 B02: 4 | Scale 1-5, max 5, EN ISO 105-X12:2001, (wet/dry) 4-5/4-5 | | Thread offset in the seam: EN ISO 13 936-2 |
| III | OCEANIC | 100% post-consumer recycled polyester including 50% Seaqual Yarn | 497g/m2 | ≥100,000 Martindale | | 5 (ISO 105 - B02), OOC16: 4/5 (ISO 105 - B02) | Scale 1-5, max 5, EN ISO 105-X12:2001, (wet/dry) 4-5/4-5 | BS EN 1021-1&2 Cigarette and Match, BS 7176 Low Hazard, BS 5852 Ignition Source 5 with EnviroFlam5, BS 7176 Medium Hazard with EnviroFlam5 | |
| III | QUEST | 100% post-consumer recycled polyester including 75% Seaqual Yarn | 330g/m2 | ≥100,000 Martindale | | 4-6 (ISO 105 - B02) | Scale 1-5, max 5, EN ISO 105-X12:2001, (wet/dry) 4/4 | BS EN 1021-1&2 Cigarette and Match, BS 7176 Low Hazard, BS 5852 Ignition Source 5 with EnviroFlam5, BS 7176 Medium Hazard with EnviroFlam5, B 3825 & A 3800-1 | |
| III | GRAIN | 2287: 92% post-consumer recycled polyester / 8% polyester 2288: 80% post-consumer recycled polyester / 20% polyeste | 439g/m2 | 100,000 Martindale (EN ISO 12947-2), double rubs wyzenbeek (ASTM D4157-07) (heavy duty upholstery) 100,000 | Scale 1-5, max 5, EN ISO 12945-2 5 | scale 1-8, max. 8 5-7 (ISO 105 - B02) | Scale 1-5, max 5, EN ISO 105-X12:2001, (wet/dry) 4-5/4-5 | BS EN 1021-1&2 Cigarette and Match, CA TB 117-2013 | |
| IV | ATLAS | New wool 90% Nylon 10% | 286g/m2 400g/lm | 100,000 Martindale EN ISO 12947 | EN ISO 12945-2 4-5 | ISO 105 B02: 6-7 | ISO 105-X12:2001, (wet/dry) 4-5/4-5 | BS EN 1021-2 Match, BS EN 1021-1 Cigarette, BS 5 5852 Crib 5, BS 5852 ignition source 3, BS 5852 Part 1, NF D 60 013, UNI 9175 1IM, US Cal. Bull. 117-2013, MED, CertificateIMO | |
| IV | LEATHER | Leather type - corrected grain leather Type of finishing - pigmented leather | | Dry: 500 cycles - min. 4 grey scale Wet: 250 cycles - min. 4 grey scale UNI EN ISO 11640 | | Light fastness: min. 4 grey scale UNI ISO 105-802 | | Match flame test: No ignition UNI EN 1021-1-2006 BS EN 1021-1-2006 | |