

# Bazalto technical specification



**.mdd**

**.mdd has a leading position among manufacturers of office furniture with many awards that prove quality and continuously increase demand for it's products.**

The realities of today`s market require constant quality improvement at all levels of modern organization. This applies in particular to customer service, marketing, quality of products and also to quality of processes within the company.

Partnership relations among employees and with business partners form a base of economic growth and success of the company.

Constant investments in innovative machinery park, optimization of management systems and an expansion of production halls allow to minimize the lead times for the product of the highest quality.

**More than twenty years of experience in office furniture industry come with reference from a long list of companies and institutions to show their appreciation for an efficient and comprehensive service.**

**.mdd is higly aware of the environment.**

Being located in the forest region with lake by itis side, .mdd takes the nature seriously and invests constantly in a modern and energy-efficient solutions to preserve the local life. Company puts emphasis on waste segregation and recycling. .mdd has been awarded for the exceptional care and involvement in waste disposal. All materials used are environmentally friendly and enjoy a high 95 % rate of being recycled.



**General informations:**

**Warranty:**

.mdd products - **5 years.**

Electrical components and fabric - **2 years.**

**Certyficate - MFC:**



**Certyficate - fabric:**



**Assembly:**

product delivered in separate elements

**Packing:**

foam wrap

<b>Bazalto</b>	Date of preparation 26.08.2021	The data contained in this document is valid in the day of its preparation. Change of the product, as long as it does not affect the basic features of it, does not require consistent updates of the document.	page 2/12 <b>general informations</b>
----------------	-----------------------------------	---	--

**Technical specification - Bazalto**

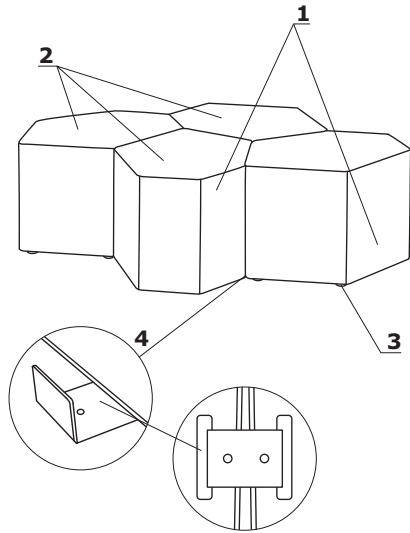

- 1. **Body** - MFC 18 mm, 28 mm and HDF 3 mm, fixed with confirmat screws
- 2. **Seat** - cut foam: thickness 50 mm
- 3. **Polypropylene feet** - Ø30 mm, 6 pcs
- 4. **Metal connecting elements** - profile 2 mm, laser-cut, powder coated, colour: black

- max. load 120 kg

**Side table - Bazalto**

- 1. **Top** - mass-dyed HPL, 10 mm thick
- 2. **Frame** - vertical column made of tube Ø30 mm, wall thickness 2 mm, powder coated
- 3. **Base** - sheet metal, powder coated steel, 5 mm thick

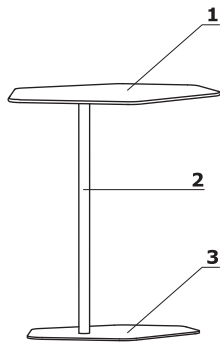

Configuration examples

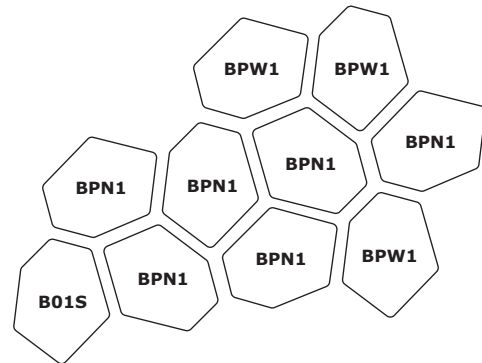
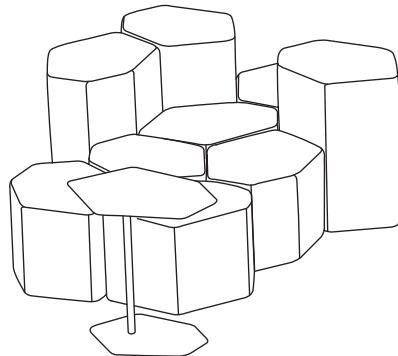
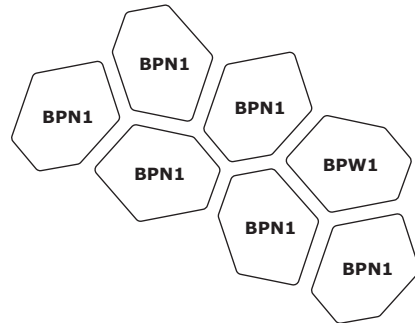
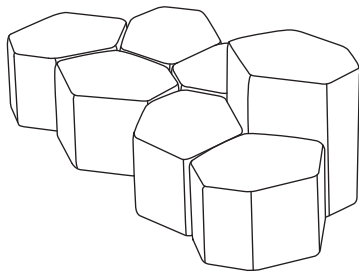
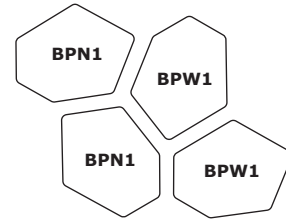
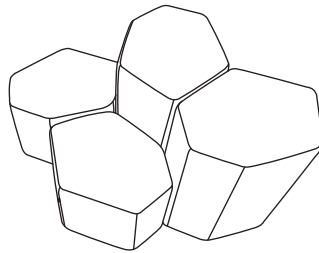
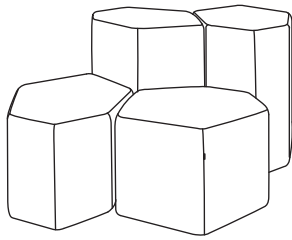
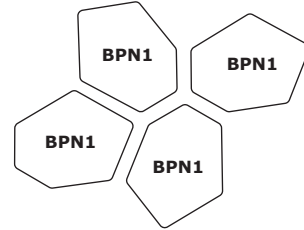
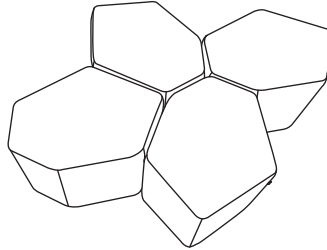
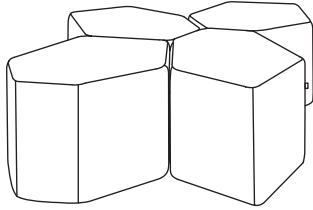
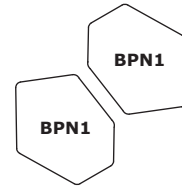
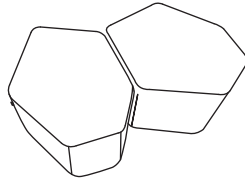
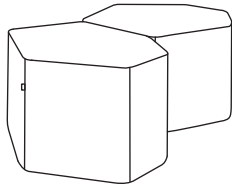

Dimensions - Bazalto

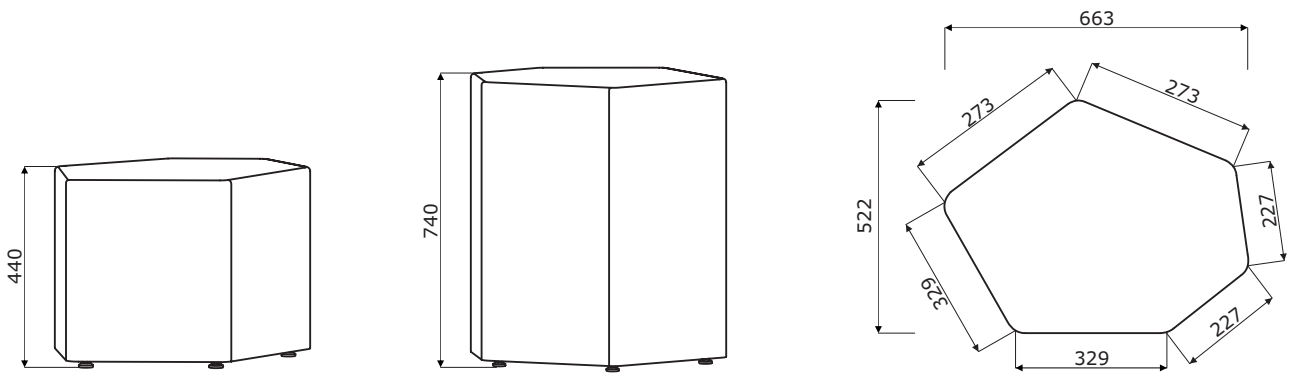

Dimensions - side tables

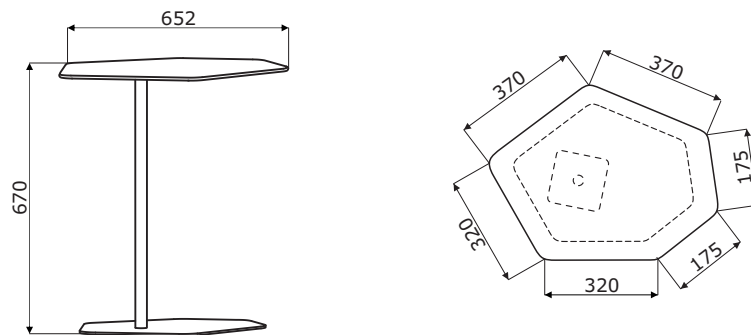

**Bazalto \***

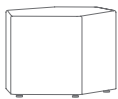

**BPN1**  
663 / 522 / 440  
18.9 kg

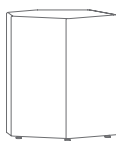

**BPW1**  
663 / 522 / 740  
14.1 kg

**Side tables \***



**B01S**  
651 / 505 / 670  
8 kg

\* dimensions expressed in millimeters: width x depth x height

<b>Bazalto</b>	Date of preparation 26.08.2021	The data contained in this document is valid in the day of its preparation. Change of the product, as long as it does not affect the basic features of it, does not require consistent updates of the document.	page 6/12
			<b>products</b>

### Fabric Nemo

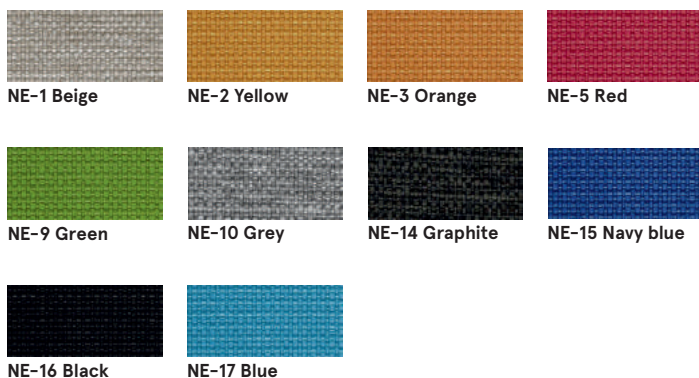

**Technical data:**

**Material** polyester 100%

**Fabric weight** 366g/m2

**Abrasion resistance rubs** PN\_EN ISO 12947 - 2:2 100,000

**Pilling resistance** scale 1-8, max. 8, PN-EN ISO 105 - B02 (3-4)

**Colour fastness to light** scale 1-5, max. 5, PN-EN 1021 - 2,

**Colour fastness to rubbing** PN-EN 1021 - 1  
skcale 1-5, max. 5, EN ISO 105x12 (wet/dry) 4-5

### Fabric Medley - second price group



**Technical data:**

**Material** polyester 100%

**Fabric weight** 510 g/lm (16.45 oz/lin.yd.)

**Abrasion resistance rubs** BS EN ISO 12947-2, 75,000 cykli Martindale

**Pilling resistance** scale 1-5, max. 5, EN ISO 12945-2 (4)

**Colour fastness to light** scale 1-8, max. 8, EN ISO 105-B02 (5-7)

**Colour fastness to rubbing** scale 1-5, max. 5, EN ISO 105x12 (wet/dry (4-5/4-5))

**Acoustic test sound absorption** ISO 354

**Flammability** BS EN 1021-1 (cigarette)  
BS 476 Part 7, Class 2  
Class Uno UNI 9174 - UNI 8457  
CA TB 117-2013  
ASTM E 84 Class I

### Fabric Atlantic \* - second price group



**Technical data:**

**Material** polyester 100%

**Fabric weight** 530 g/lm (17.09 oz/lin.yd.)

**Abrasion resistance rubs** BS EN ISO 12947-2, 110,000 Martindale cycles

**Pilling resistance** scale 1-5, max. 5, EN ISO 12945-2 (4-5)

**Colour fastness to light** scale 1-8, max. 8, EN ISO 105-B02 (5-7)

**Colour fastness to rubbing** scale 1-5, max. 5, EN ISO 105x12 (wet/dry)

**Flammability** CA TB 117-2013  
ASTM E 84 Class I  
BS EN 1021-2 (match)  
BS EN 1021-1 (cigarette)

\* There is a possibility of ordering the product in full colour spectrum of Atlantic range, as per Gabriel's pattern book, within 8 weeks

**Fabric Vita – second price group**



**Technical data:**

**Material** Surface: 98,5% PVC, 1,5% PU  
Substrate: 50% poliester, 50% Cotton

**Fabric weight** 850g/m2 ± 10% (1190G/lin. m ± 10%)

**Abrasion resistance rubs** BS EN ISO 5470-2, 100,000 Martindale cycles

**Colour fastness to light** 6 (ISO 105 - B02)

**Colour fastness to rubbing** wet: 4, dry: 4 (ISO 105 - X12)

**Flammability** BS EN 1021 - (cigarette)  
BS EN 1021 - 2 (match)  
BS 5852 - (Ignition Source 5)  
BS 7176 - (Medium Hazard)

**Flexes** BS EN ISO 7854 - Method B,  
400.000 Flexing cycles

**Anti-microblal / Anti-fungal** AATCC 147

**Fabric Charles – second price group**



**Technical data:**

**Material** 100% polyester

**Fabric weight** 433g/m2

**Abrasion resistance rubs** 90,000 Martindale cycles (EN ISO 12947-2)

**Pilling resistance** EN ISO 12945-2, 5

**Light fastness** EN ISO 105-B02, 5

**Rubbing fastness** dry: 4-5, wet: 4-5, EN ISO 105x12

**Flammability** EN 1021, 1



### Fabric Mica - second price group

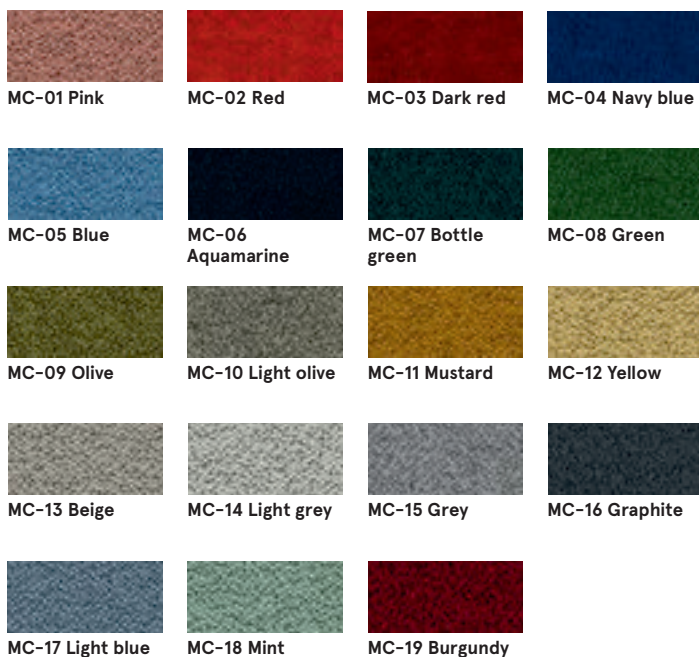

**Technical data:**

**Material** post-consumer recycled polyester 97%, polyester 3%

**Fabric weight** 305 g/lm

**Abrasion resistance rubs** 60,000 rubs martindale (EN ISO 12947-2)

**Pilling resistance** scale 1-5, max. 5 - EN ISO 12945-2, 4-5

**Light fastness** scale 1-8, max. 8 - EN ISO 105-B02, 5-8

**Rubbing fastness** dry: 4-5, wet: 4-5, scale 1-5, max. 5 - EN ISO 105x12

**Flammability** CA TB 117-2013  
ASTM E 84 Class I  
BS EN 1021-1 Cigarette  
BS EN 1021-2 Match  
BS 476 Part 7 class I

### Fabric Go Check - second price group

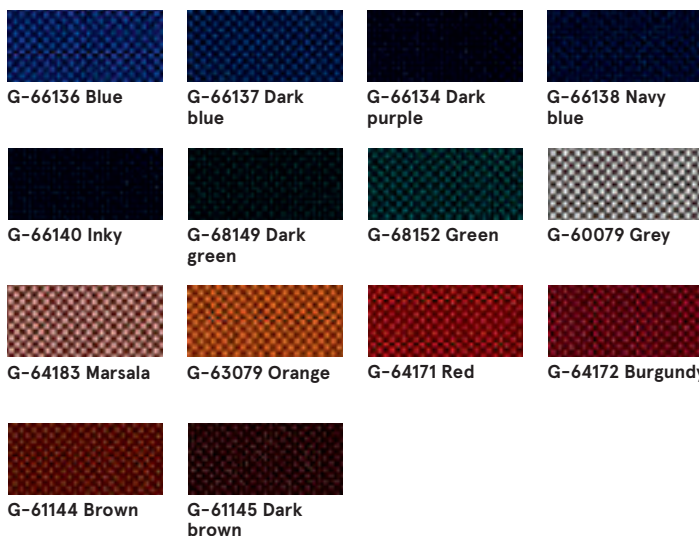

**Technical data:**

**Material** 100% Trevira CS

**Fabric weight** 435g/lm

**Abrasion resistance rubs** 80,000 rubs martindale (EN ISO 12947-2)

**Pilling resistance** scale 1-5, max. 5 - EN ISO 12945-2, 5

**Light fastness** scale 1-8, max. 8 - EN ISO 105-B02, 5-8

**Rubbing fastness** dry: 4-5, wet: 4-5, scale 1-5, max. 5 - EN ISO 105x12

**Flammability** BS EN 1021 1&2 Cigarette and Match  
BS EN 1021-1 Cigarette  
BS 5852 Crib 5  
BS 7176 Medium hazard  
DIN 4102 - B1  
NFP 92-503/504/505 M1  
ÖNORM A3800-B1-B3825-Q1 UK  
Class Uno UNI 9175 Class 1 I EMME  
FAR/JAR 25.853 (a) (i) (ii)  
CA TB 117-2013  
DIN EN 13501-1 B-s1,d0  
AM 18 - NF D 60-013-(only for fabric)

### Fabric Xtreme - third price group



**Technical data:**

**Material** 100% Trevira Clame (CS)  
100% Recykling (YS)  
Flame Retardant polyester.  
Non metallic dyestuffs.

**Fabric weight** 310 g/m2 ±5% (435g/lin.m ±5%)

**Abrasion resistance rubs** 60,000 Martindale cycles (CS)  
100,000 Martindale cycles (YS)

**Colour fastness to light** 6 (ISO 105 - B02)

**Colour fastness to rubbing** wet: 4, dry: 4 (ISO 105 - X12)

**Flammability** EN 1021 - 1 (cigarette),  
EN 1021 - 2 (match)  
BS 7176 Low Hazard,  
NF P92-507 M1, DIN 4102 B1,  
UNI 9175 Class 1 IM, UNI 8456,  
UNI 9174 & UNI 9177 Classe Uno,  
ÖNORM B 3825 & A 3800-1  
NF D 60-013

### Fabric Synergy - third price group

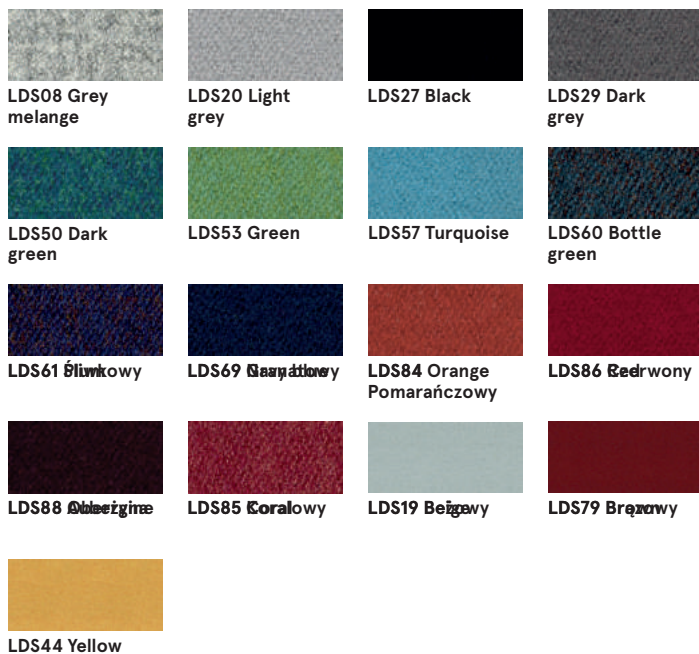

**Technical data:**

**Material** 95% Virgin Wool, 5% Poliamid

**Fabric weight** 400g/m2 ±5% (560 g/lin.m ±5%)

**Abrasion resistance rubs** Independently certified  
≥100,000 Martindale cycles

**Colour fastness to light** 5 (ISO 105 - B02)

**Colour fastness to rubbing** ISO 105 - X12 - wet: 4, dry: 4

**Flammability** EN 1021 - 1 (cigarette),  
EN 1021 - 2 (match),  
BS 7176 Low Hazard,  
UNI 9175 Classe 1 IM,  
ÖNORM B 3825 & A 3800-1

## Fabric Silvertex – third price group

There is a possibility of ordering the product in full colour spectrum of Silvertex range, as per Spradling’s pattern book, within 15 working days.

### Technical data:

<b>Material</b>	Topcoat: 100% Vinyl Backing: 100% Polyesterr Hi-Loft™
<b>Fabric weight</b>	685 gr/m2
<b>Abrasion resistance</b>	>300,000 cycles Martindale
<b>UV-resistance</b>	>= 7 (1000 hours, blue wool scale)
<b>Cold Crack resistance</b>	-23°C
<b>Flame retardancy</b>	NF P 92-503 / M2 EN 1021, Part 1&2 DIN 4102 B2 ÖNORM B 3825, Gruppe I – Schwerbrennbares Verhalten ÖNORM A 3800, Teil I, Qualmbildungsklasse QI – schwachqualmend IMO Res. MSC.307 (88) (2010 FTP Code) Annex I Part 8 (MED) Marine Equipment Directive in its current valid version UNI 9175 (1987) / UNI 9175/FAI (1994) Classe I.IM (uno I EMME) UNE 23.727-90 IR /M2 EN 71-2: 2006+AI: 2007 Safety of Toys – Part 2: Flammability ECE R 118 (replaces Directive 95/28/EC) FMVSS 302 FAR 25/853
<b>Antimicrobial</b>	Antifungal Protection, Antibacterial Protection, Antimycotic Protection

## Fabric Atlas – fourth price group



### Technical data:

<b>Material</b>	90% new wool, 10% nylon
<b>Fabric weight</b>	286g/m2, 400g/lm
<b>Abrasion resistance rubs</b>	100,000 cyklí Martindale, EN ISO 12947
<b>Colour fastness to light</b>	ISO 105 B02: 6-7
<b>Colour fastness to rubbing</b>	ISO 105-X12:2001, (wet/dry) 4-5/4-5
<b>Flammability</b>	BS EN 1021-2 Match, BS EN 1021-1 Cigarette, BS 5 5852 Crib 5, BS 5852 ignition source 3, BS 5852 Part 1, NF D 60 013, UNI 9175 1M, US Cal. Bull. 117-2013

## Fabric Field2 – fourth price group



### Technical data:

<b>Material</b>	100% Trevira CS
<b>Fabric weight</b>	321g/m2, 450g/lm
<b>Abrasion resistance rubs</b>	100,000 cyklí Martindale, EN ISO 12947
<b>Colour fastness to light</b>	ISO 105 B02: 5-7
<b>Flammability</b>	BS EN 1021-2 Match, BS EN 1021-1 Cigarette, BS 5 5852 Crib 5, DIN 4102 B1 FAR 25.853, UNI 9177 classe 1, US Cal. Bull. 117-2013

**Leather - fourth price group**



**Technical data:**

**Material**    Leather type - corrected grain leather  
 Type of finishing - pigmented leather

**Abrasion resistance rubs**    Dry: 500 cycles - min. 4 grey scale  
 Wet: 250 cycles - min. 4 grey scale  
 UNI EN ISO 11640

**Colour fastness to light**    Light fastness: min. 4 grey scale,  
 UNI ISO 105-802

**Flammability**    No ignition  
 UNI EN 1021-1-2006  
 BS EN 1021-1-2006

**Top B01S - HPL**



**Base B01S - metal**

