

Storages and bookcase - Standard technical specification



.mdd

.mdd has a leading position among manufacturers of office furniture with many awards that prove quality and continuously increase demand for it's products.

The realities of today`s market require constant quality improvement at all levels of modern organization. This applies in particular to customer service, marketing, quality of products and also to quality of processes within the company.

Partnership relations among employees and with business partners form a base of economic growth and success of the company.

Constant investments in innovative machinery park, optimization of management systems and an expansion of production halls allow to minimize the lead times for the product of the highest quality.

More than twenty years of experience in office furniture industry come with reference from a long list of companies and institutions to show their appreciation for an efficient and comprehensive service.

.mdd is highly aware of the environment.

Being located in the forest region with lake by it's side, .mdd takes the nature seriously and invests constantly in a modern and energy-efficient solutions to preserve the local life. Company puts emphasis on waste segregation and recycling. .mdd has been awarded for the exceptional care and involvement in waste disposal. All materials used are environmentally friendly and enjoy a high 95 % rate of being recycled.



General informations:

Warranty:

.mdd products – **5 years**.

Electrical components and fabric – **2 years**.

Certificate - MFC:



Assembly:

product delivered in separate elements

Packing:

cardboard, bubble wrap, stretch foil

Compliant with standards:

PN-EN 14073-2:2006

Boards density:

12 mm - 690 - 750 kg/m³

18 mm - 650 - 690 kg/m³

28 mm - 610 - 630 kg/m³

36 mm - 610 - 630 kg/m³

Storages and bookcase

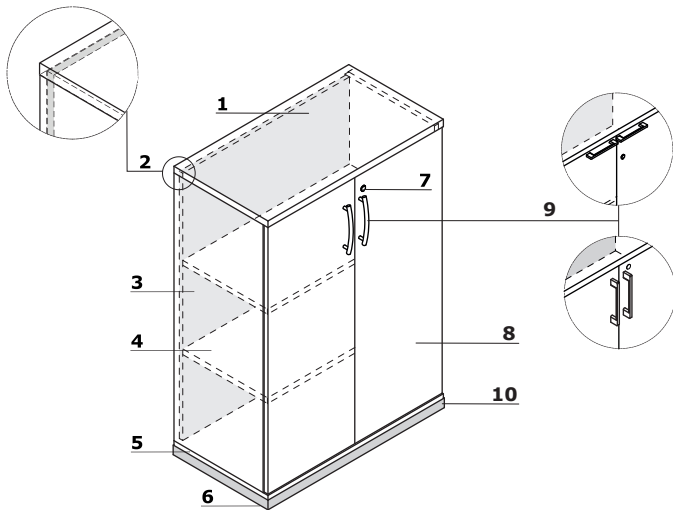

1. **Top** - MFC 28 mm, ABS edge
2. **Back MFC** - 18 mm, ABS edges
3. **Body** - MFC 18 mm, ABS edge
4. **Shelf** - MFC 18 mm, protection against accidental falling-out, ABS edge
5. **Base** - MFC 18 mm, ABS edge
6. **Leveling feet 27 mm** - range 5 mm
7. **OPTION WITH EXTRA CHARGE** - espagnolette lock - two-point
8. **Front** - MFC 18 mm, ABS edge, plain hinge 110°
9. **Aluminum handle:**
 - Standard
 - OPTION WITH EXTRA CHARGE - Pro (vertical) - colour: white, black, aluminium
 - OPTION WITH EXTRA CHARGE - Pro (horizontal) + espagnolette lock - colour: white, black, aluminium
10. **OPTION WITH EXTRA CHARGE** - metal base - colour: M009 - aluminium semi-matt

Storages *

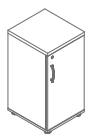

A26P2**
402 / 432 / 777
25.3 kg



A36P2**
402 / 432 / 1129
33.3 kg



A56P2**
402 / 432 / 1833
67.8 kg

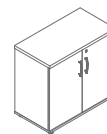

A21B4
801 / 432 / 740
43.05 kg

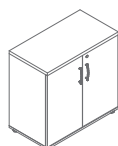

A2104
801 / 432 / 777
44.55 kg

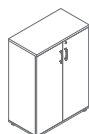

A3104
801 / 432 / 1129
59.85 kg

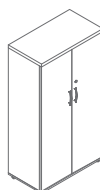

A4104
801 / 432 / 1481
71.8 kg

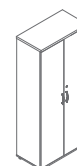

A5104
801 / 432 / 1833
94.2 kg



A6104
801 / 432 / 2185
105.85 kg

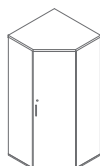

A5NP4**
802 / 802 / 1833
116.65 kg

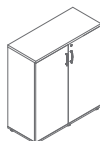

A3105
1000 / 432 / 1129
75.65 kg

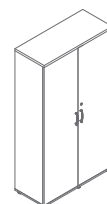

A5105
1000 / 432 / 1833
115.75 kg

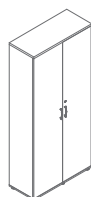

A6105
1000 / 432 / 2185
137.15 kg

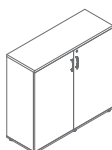

A3106
1200 / 432 / 1129
85.8 kg

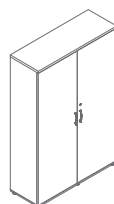

A5106
1200 / 432 / 1833
130.8 kg

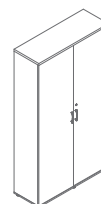

A6106
1200 / 432 / 2185
153.15 kg

* dimensions expressed in millimeters: width x depth x height
** option - left hand side or right hand side front

Bookcases *

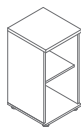

A2902
402 / 432 / 777
25.25 kg

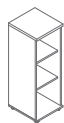

A3902
402 / 432 / 1129
29 kg



A5902
402 / 432 / 1833
42.2 kg

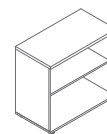

A25B4
801 / 432 / 740
34.25 kg

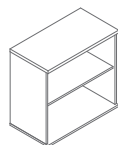

A2504
801 / 432 / 777
34.55 kg

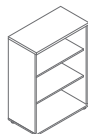

A3504
801 / 432 / 1129
46.75 kg

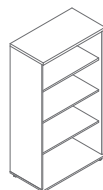

A4504
801 / 432 / 1481
55.5 kg



A5504
801 / 432 / 1833
68.65 kg

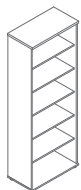

A6504
801 / 432 / 2185
79.95 kg



A3505
1000 / 432 / 1129
57.5 kg

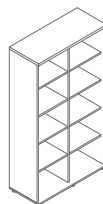

A4505
1000 / 432 / 1833
92.4 kg

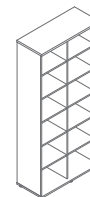

A6505
1000 / 432 / 2185
8103.55 kg

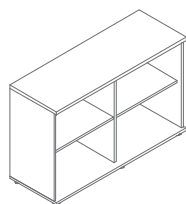

A2506
1200 / 432 / 777
48.6 kg

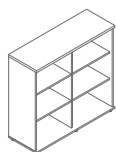

A3506
1200 / 432 / 1129
65 kg

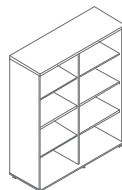

A4506
1200 / 432 / 1481
81.9 kg

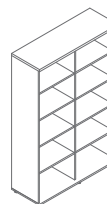

A5506
1200 / 432 / 1833
101.7 kg

www.mdd.eu

* dimensions expressed in millimeters: width x depth x height

Bookcases *

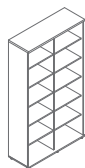

A6506
1200 / 432 / 2185
115.1 kg

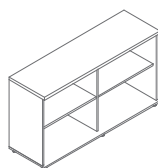

A2508
1600 / 432 / 777
59 kg

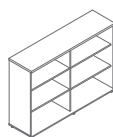

A3508
1600 / 432 / 1129
82.05 kg

Half bookcases *



A38P2**
402 / 432 / 1129
32.1 kg



A58P2**
402 / 432 / 1833
46.05 kg

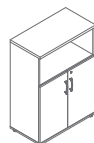

A3404
801 / 432 / 1129
55.05 kg

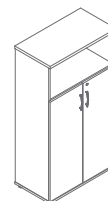

A4304
801 / 432 / 1481
69.7 kg

www.mdd.eu

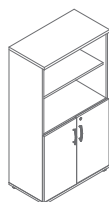

A4404
801 / 432 / 1481
65.9 kg

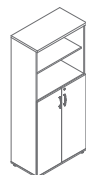

A5304
801 / 432 / 1833
82. kg

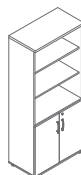

A5404
801 / 432 / 1833
77.2 kg

Desk cabinet *

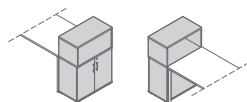

A3404B
801 / 432 / 1129
54.8 kg

* dimensions expressed in millimeters: width x depth x height
** option - left hand side or right hand side front

Stack-on storages 2OH *

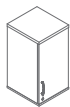

A16P2**
402 / 432 / 750
23.6 kg

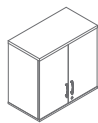

A1104
801 / 432 / 750
30.75 kg

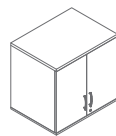

A1204
801 / 600 / 750
41.15 kg

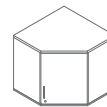

A1NP4**
802 / 802 / 750
52.05 kg

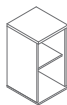

A1902
402 / 432 / 750
20.05 kg

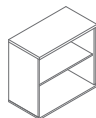

A1504
801 / 432 / 750
32.45 kg

Printer storage *

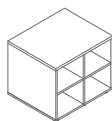

S85
710 / 600 / 600
35.6 kg

* dimensions expressed in millimeters: width x depth x height
** option - left hand side or right hand side front

Top, base, body, front



08 Black *



26 Aluminum satinato *



31 Canadian oak



39 Polar birch



64 Cocoa

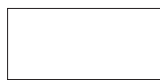

67 White pastel *



106 Lowland walnut



154 Anthracite *



167 Grey oak



168 Natural oak

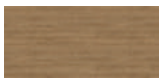

169 Honey oak

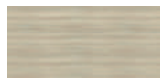

170 Acacja

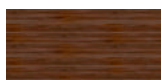

171 Dark walnut

* body - II group