

Ogi Y

technical specification



.mdd

.mdd has a leading position among manufacturers of office furniture with many awards that prove quality and continuously increase demand for it's products.

The realities of today`s market require constant quality improvement at all levels of modern organization. This applies in particular to customer service, marketing, quality of products and also to quality of processes within the company.

Partnership relations among employees and with business partners form a base of economic growth and success of the company.

Constant investments in innovative machinery park, optimization of management systems and an expansion of production halls allow to minimize the lead times for the product of the highest quality.

More than twenty years of experience in office furniture industry come with reference from a long list of companies and institutions to show their appreciation for an efficient and comprehensive service.

.mdd is higly aware of the environment.

Being located in the forest region with lake by itis side, .mdd takes the nature seriously and invests constantly in a modern and energy-efficient solutions to preserve the local life. Company puts emphasis on waste segregation and recycling. .mdd has been awarded for the exceptional care and involvement in waste disposal. All materials used are environmentally friendly and enjoy a high 95 % rate of being recycled.



General informations:

Warranty:

.mdd products – **5 years.**

Electrical components and fabric – **2 years.**

Certificate - MFC:



Assembly:

product delivered in separate elements

Packing:

cardboard

Compliant with standards:

PN-EN 527-2:2017-02

Boards density:

12 mm - 690 - 750 kg/m³

18 mm - 650 - 690 kg/m³

28 mm - 610 - 630 kg/m³

36 mm - 610 - 630 kg/m³

Ogi desk worktops

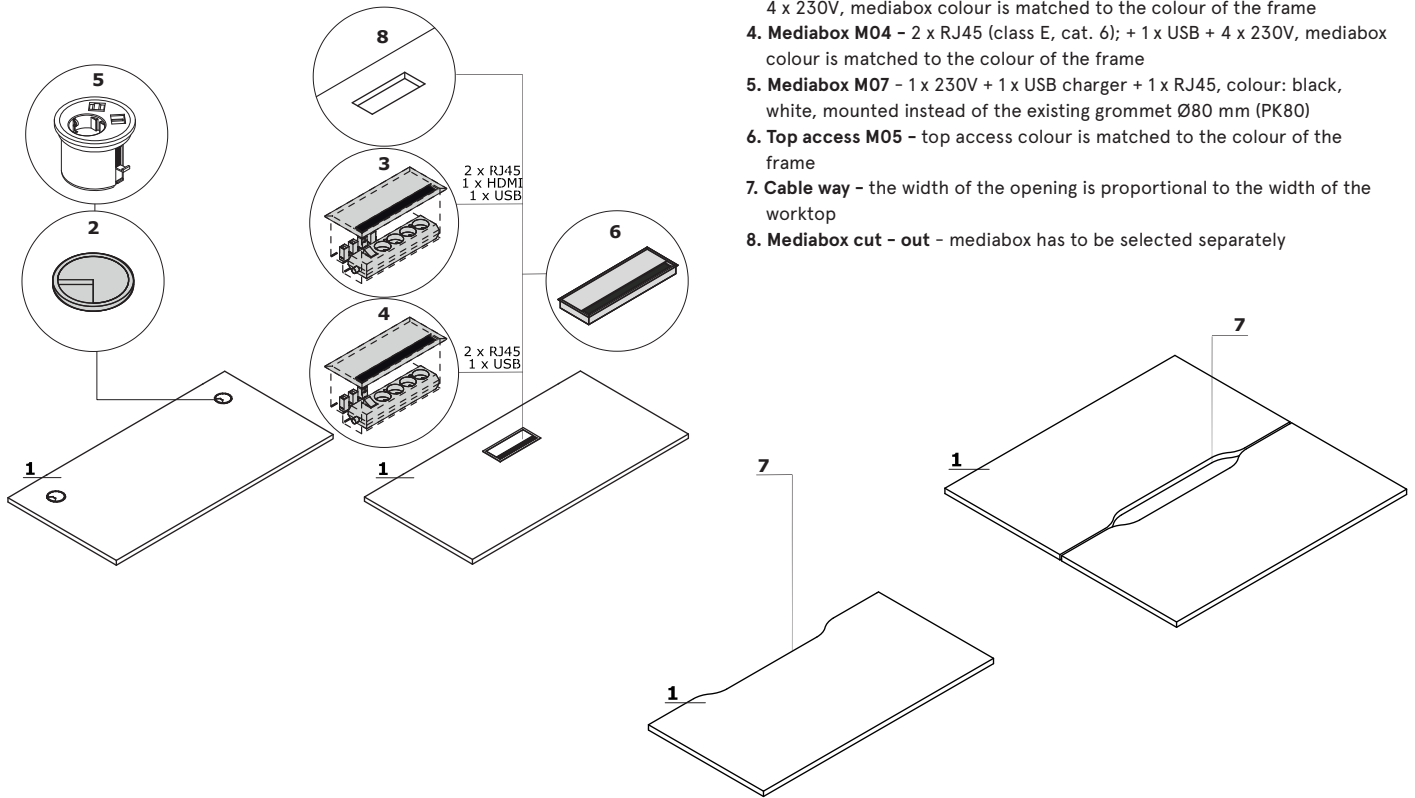

- 1. Worktop - MFC 28 mm, ABS edge
- OPTIONS WITH EXTRA CHARGE:**
- 2. Grommet - 2 pcs, Ø 80 mm
- 3. Mediabox M04H - 2 x RJ45 (class E, cat. 6); + 1 x USB + 1 x HDMI + 4 x 230V, mediabox colour is matched to the colour of the frame
- 4. Mediabox M04 - 2 x RJ45 (class E, cat. 6); + 1 x USB + 4 x 230V, mediabox colour is matched to the colour of the frame
- 5. Mediabox M07 - 1 x 230V + 1 x USB charger + 1 x RJ45, colour: black, white, mounted instead of the existing grommet Ø80 mm (PK80)
- 6. Top access M05 - top access colour is matched to the colour of the frame
- 7. Cable way - the width of the opening is proportional to the width of the worktop
- 8. Mediabox cut - out - mediabox has to be selected separately

Dimensions of radial worktops (mm)

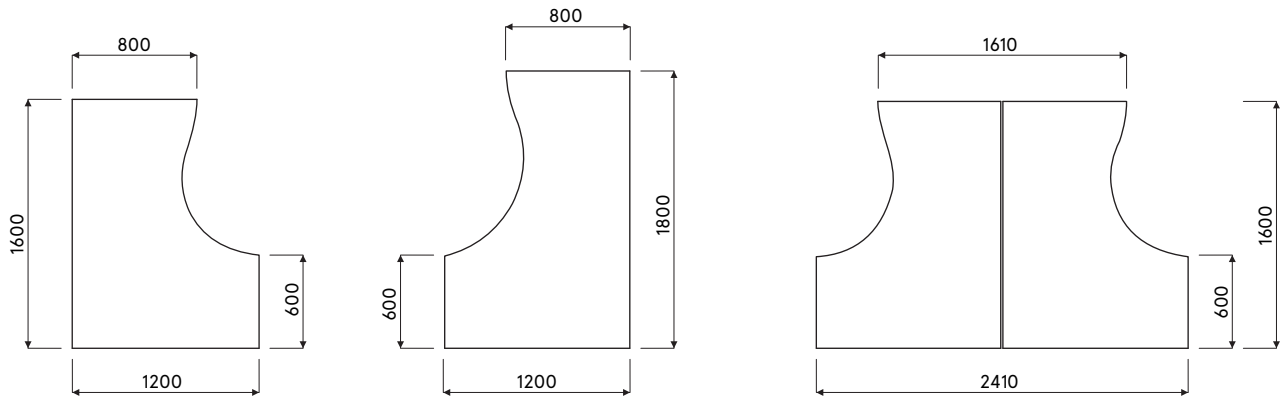

Frame

Ogi Y: powder coated steel, profile 40x40 mm, spacer 10 mm between top and frame

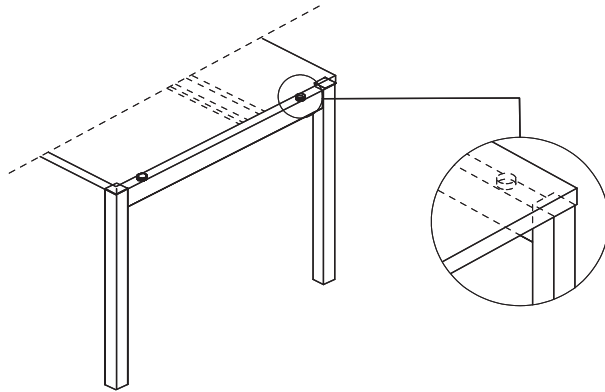

Attention - the cable tray located underneath the worktop is only available in: M009 - aluminium semi-matte colour

Desk with managerial storage

- 1. **Worktop** - MFC 28 mm, ABS edge
- 2. **Top** - MFC 28 mm, ABS edge
- 3. **Shelf** - MFC 18 mm, protection against accidental falling-out, ABS edge
- 4. **Drawer** - MFC 18 mm, ABS edge, patent lock - possible to change location
- 5. **Base** - MFC 18 mm, ABS edge
- 6. **Front** - MFC 18 mm, ABS edge

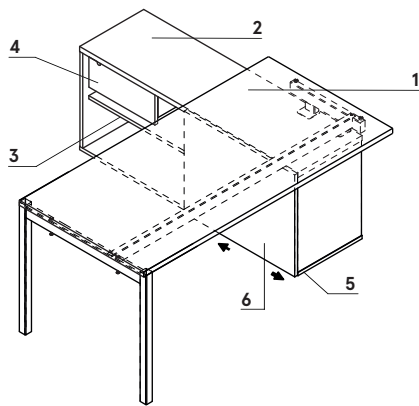

www.mdd.eu

Configuration examples (mm)

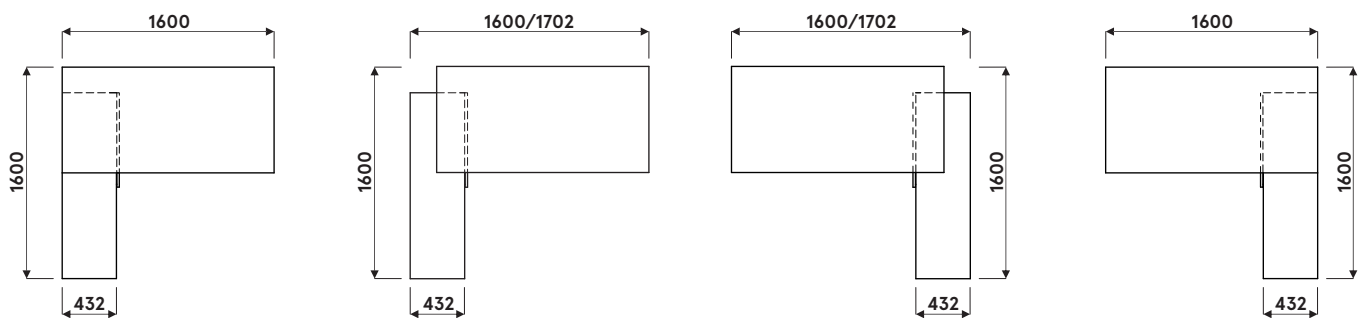

Ogi Y	Date of preparation 30.11.2021	The data contained in this document is valid in the day of its preparation. Change of the product, as long as it does not affect the basic features of it, does not require consistent updates of the document.	page 4/12 technical description
-------	-----------------------------------	---	---

Configuration examples (mm)

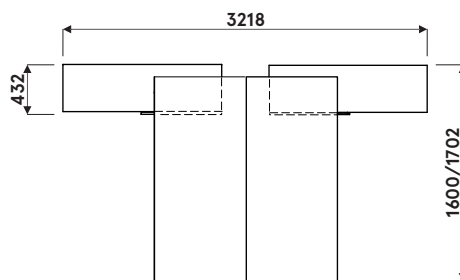
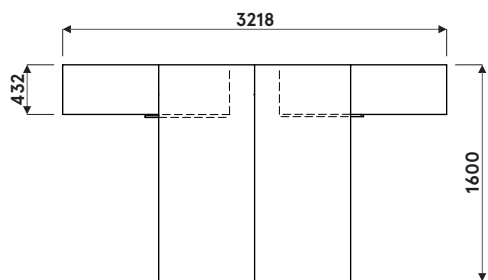

Configuration examples with BOX40, BOX50, BOX60

www.mdd.eu

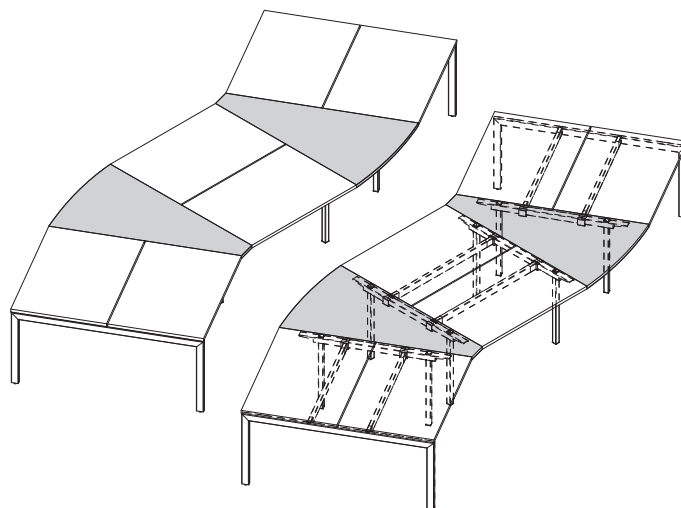
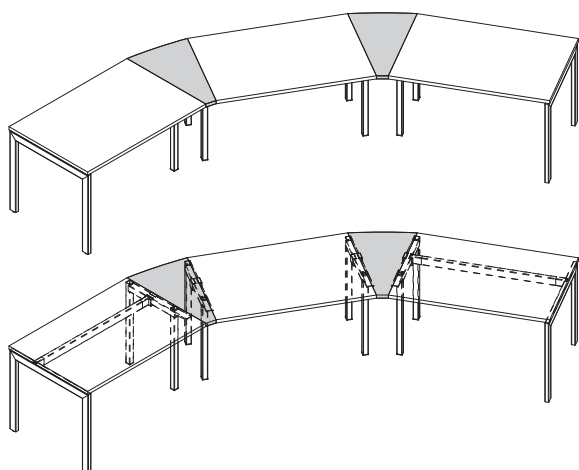

ATTENTION - only for Ogi Q, Ogi U, Ogi Y, Ogi M

Accessories

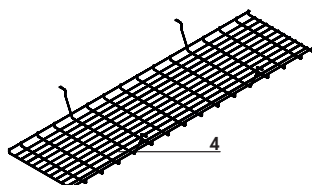
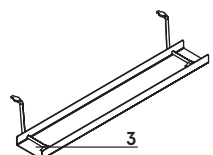
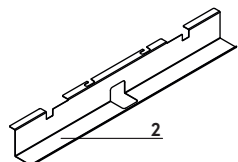
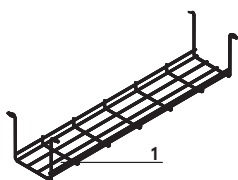

1. Horizontal cable tray S69 - powder coated, colour: 09 - aluminum
2. Single desk horizontal cable tray (SG12, SG16) - powder coated metal, colour: M009 - aluminum semi-matt
3. Horizontal cable tray E64 - powder coated, colour: M009 - aluminium semi-matt
4. Cable tray for bench desks (SG220, SG260) - steel wire Ø4 mm, powder coated, colour: 09 - aluminum

Ogi Y	Date of preparation 30.11.2021	The data contained in this document is valid in the day of its preparation. Change of the product, as long as it does not affect the basic features of it, does not require consistent updates of the document.	page 5/12 technical description
-------	-----------------------------------	---	------------------------------------

Sliding top

1. Sliding top - shifting range 141 mm

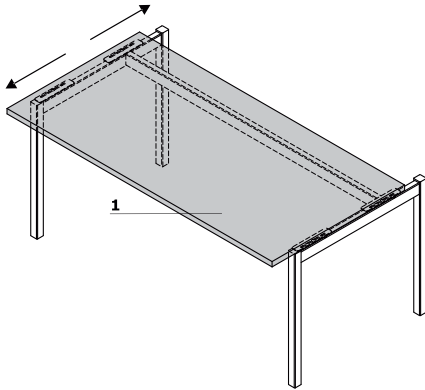

Note – M04, M04H, and M07 mediaboxes cannot be installed.

Power strip – for series connection

- 1. **PWS1** – set for 1 workstation – power strip (3x SCHUCKO, 2x RJ45) x1 + power cord (universal outlet PL/FR/Schucko)
- 2. **PWS2** – set for 2 workstation – power strip (3x SCHUCKO, 2x RJ45) x2 + set of power cords (universal outlet PL/FR/Schucko)
- 3. **PWS3** – set for 3 workstation – power strip (3x SCHUCKO, 2x RJ45) x3 + set of power cords (universal outlet PL/FR/Schucko)

1

2

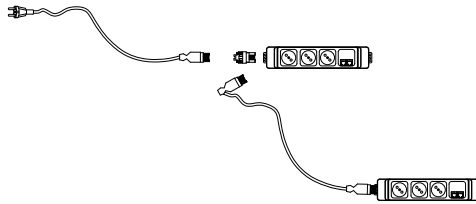
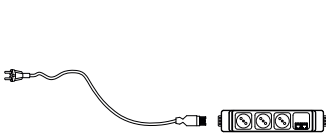

3

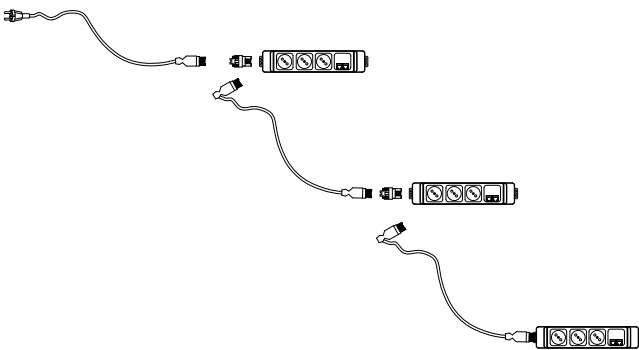

Desks *

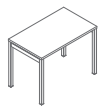

BOY01
1000 / 600 / 740
27.3 kg



BOY12
1200 / 600 / 740
31 kg

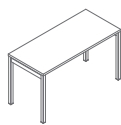

BOY14
1400 / 600 / 740
33.5 kg

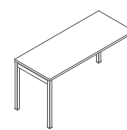

BOY16
1600 / 600 / 740
36.8 kg

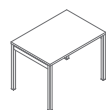

BOY20
1000 / 700 / 740
26.1 kg



BOY22
1200 / 700 / 740
33.8 kg

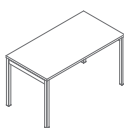

BOY24
1400 / 700 / 740
35.4 kg

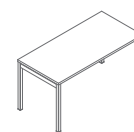

BOY26
1600 / 700 / 740
38.95 kg

www.mdd.eu

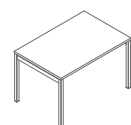

BOY02
1200 / 800 / 740
36.8 kg

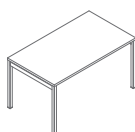

BOY03
1400 / 800 / 740
39.3 kg

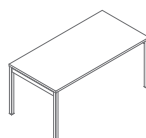

BOY04
1600 / 800 / 740
44.35 kg

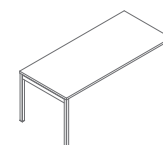

BOY05
1800 / 800 / 740
48.35 kg

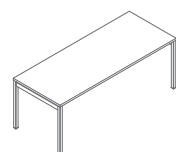

BOY06
2000 / 800 / 740
49.15 kg

* dimensions expressed in millimeters: width x depth x height

Ogi Y	Date of preparation 30.11.2021	The data contained in this document is valid in the day of its preparation. Change of the product, as long as it does not affect the basic features of it, does not require consistent updates of the document.	page 7/12
			products

Elements for arrangement building - straight desk *

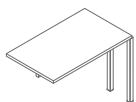

BOX10
1000 / 600 / 740
20.7 kg

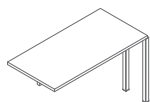

BOX12
1200 / 600 / 740
22.7 kg

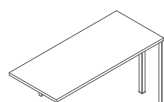

BOX14
1400 / 600 / 740
25.4 kg

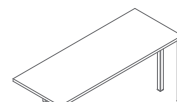

BOX16
1600 / 600 / 740
28.9 kg

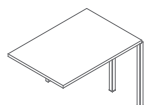

BOX30
1000 / 700 / 740
20.7 kg

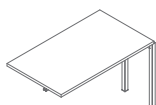

BOX32
1200 / 700 / 740
28.4 kg

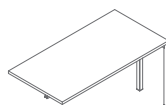

BOX34
1400 / 700 / 740
30 kg

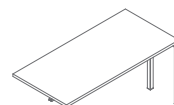

BOX36
1600 / 700 / 740
33.55 kg



BOX40
500 / 800 / 740
11 kg

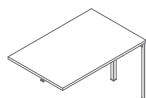

BOX42
1200 / 800 / 740
30.8 kg

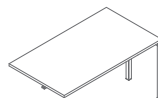

BOX43
1400 / 800 / 740
33.3 kg

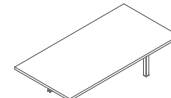

BOX44
1600 / 800 / 740
38.35 kg

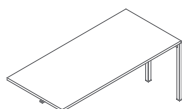

BOX45
1800 / 800 / 740
42.35 kg

* dimensions expressed in millimeters: width x depth x height

Radial desks *



BOY10
1600 / 1200 / 740
48.15 kg

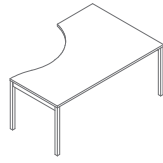

BOY17
1800 / 1200 / 740
51 kg

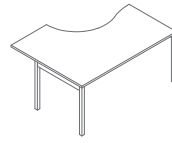

BOY11
1600 / 1200 / 740
47.45 kg

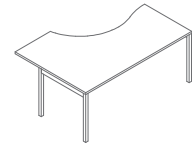

BOY18
1800 / 1200 / 740
50.65

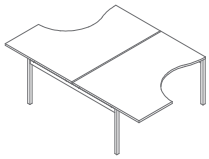

BOY15
1600 / 2410 / 740
88.7 kg

Desks with managerial storage *

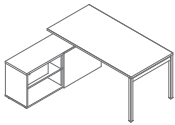

BOYL20
1600-1702 / 1600 / 740
104.35 kg

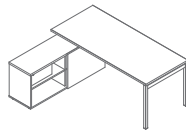

BOYL21
1800-1902 / 1600 / 740
106.75 kg

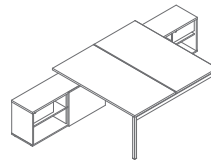

BOYL40
1600-1702 / 3210 / 740
202.4 kg

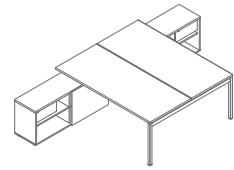

BOYL41
1800-1902 / 3210 / 740
210.4 kg

Desk extensions *

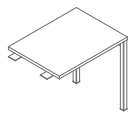

PLY01
600 / 800 / 740
18.1 kg

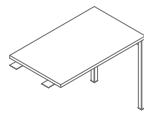

PLY02
600 / 1000 / 740
20.1 kg

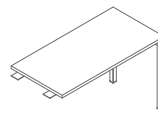

PLY03
600 / 1200 / 740
22.3 kg

* dimensions expressed in millimeters: width x depth x height

Ogi Y	Date of preparation 30.11.2021	The data contained in this document is valid in the day of its preparation. Change of the product, as long as it does not affect the basic features of it, does not require consistent updates of the document.	page 9/12
			products

Bench desks *

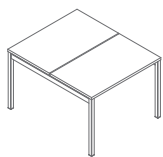

BOY50
1000 / 1210 / 740
43.3 kg

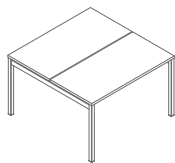

BOY52
1200 / 1210 / 740
47.3 kg

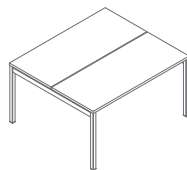

BOY54
1400 / 1210 / 740
52.7 kg

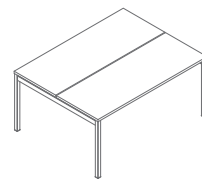

BOY56
1600 / 1210 / 740
59.7 kg

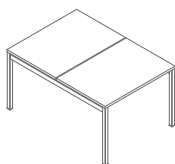

BOY40
1000 / 1410 / 740
46 kg

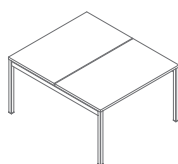

BOY42
1200 / 1410 / 740
61.4 kg

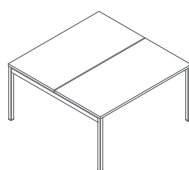

BOY44
1400 / 1410 / 740
64.6 kg

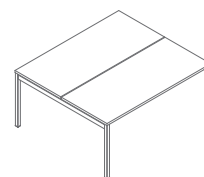

BOY46
1600 / 1410 / 740
71.7 kg

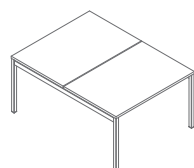

BOY32
1200 / 1610 / 740
66.7 kg

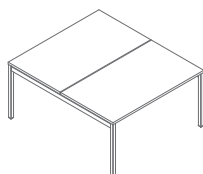

BOY33
1400 / 1610 / 740
71.7 kg

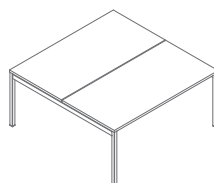

BOY34
1600 / 1610 / 740
81.8 kg

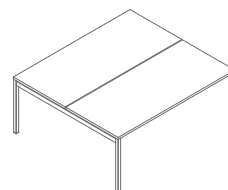

BOY35
1800 / 1610 / 740
89.8 kg

www.mdd.eu

Elements for arrangement building - bench *

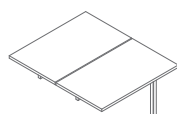

BOX20
1000 / 1210 / 740
36.6 kg

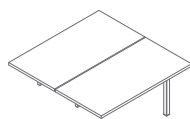

BOX22
1200 / 1210 / 740
40.6 kg

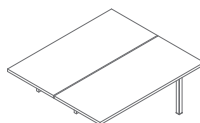

BOX24
1400 / 1210 / 740
46 kg

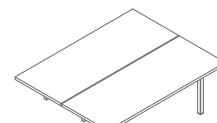

BOX26
1600 / 1210 / 740
53 kg

* dimensions expressed in millimeters: width x depth x height

Elements for arrangement building - bench *



BOX50
1000 / 1410 / 740
24.05 kg

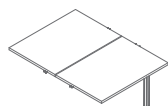

BOX51
1000 / 1410 / 740
38.2 kg

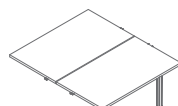

BOX52
1200 / 1410 / 740
53.6 kg

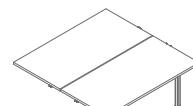

BOX54
1400 / 1410 / 740
56.8 kg

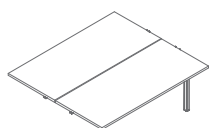

BOX56
1600 / 1410 / 740
63.9 kg

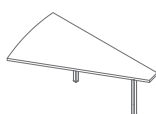

BOX60
1000 / 1610 / 740
28.75 kg

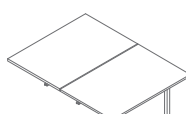

BOX62
1200 / 1610 / 740
58.35 kg

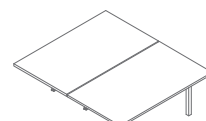

BOX64
1400 / 1610 / 740
63.35 kg

www.mdd.eu

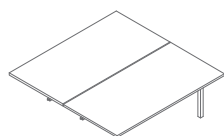

BOX66
1600 / 1610 / 740
73.45 kg

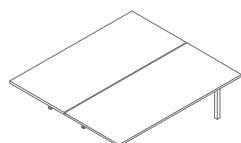

BOX68
1800 / 1610 / 740
81.45 kg

Power strip *



PWS1
500 / 430 / 569
1.1 kg



PWS2
500 / 430 / 569
1.6 kg

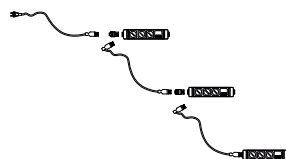

PWS3
500 / 430 / 569
2.1 kg

* dimensions expressed in millimeters: width x depth x height

Ogi Y	Date of preparation 30.11.2021	The data contained in this document is valid in the day of its preparation. Change of the product, as long as it does not affect the basic features of it, does not require consistent updates of the document.	page 11/12
			products

Worktop



26 Aluminum satinato



31 Canadian oak *



39 Polar birch *

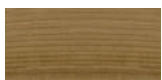

64 Cocoa *



168 Natural oak *

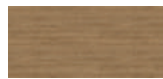

169 Honey oak*



170 Acacia *



67 White pastel



171 Dark walnut*



106 Lowland walnut *



154 Anthracite



08 Black



167 Grey oak *

Grommet



Aluminum



Beige



White



Black

Frame, mediabox - metal



M009 Aluminum semi-matt RAL9006



M015 White semi-matt RAL9010



M154 Antracite semi-matt RAL7043



M115 Black semi-matt RAL9005

* body - II group