

Ogi M technical specification



.mdd

.mdd has a leading position among manufacturers of office furniture with many awards that prove quality and continuously increase demand for it's products.

The realities of today`s market require constant quality improvement at all levels of modern organization. This applies in particular to customer service, marketing, quality of products and also to quality of processes within the company.

Partnership relations among employees and with business partners form a base of economic growth and success of the company.

Constant investments in innovative machinery park, optimization of management systems and an expansion of production halls allow to minimize the lead times for the product of the highest quality.

More than twenty years of experience in office furniture industry come with reference from a long list of companies and institutions to show their appreciation for an efficient and comprehensive service.

.mdd is higly aware of the environment.

Being located in the forest region with lake by itis side, .mdd takes the nature seriously and invests constantly in a modern and energy-efficient solutions to preserve the local life. Company puts emphasis on waste segregation and recycling. .mdd has been awarded for the exceptional care and involvement in waste disposal. All materials used are environmentally friendly and enjoy a high 95 % rate of being recycled.



General informations:

Warranty:

.mdd products – **5 years.**

Electrical components and fabric – **2 years.**

Certificate - MFC:



Compliant with standards:

PN-EN 527-2:2017-02

Boards density:

12 mm - 690 - 750 kg/m³

18 mm - 650 - 690 kg/m³

28 mm - 610 - 630 kg/m³

36 mm - 610 - 630 kg/m³

Assembly:

product delivered in separate elements

Packing:

cardboard, perforated plastic mesh wrap

Ogi M	Date of preparation 30.11.2021	The data contained in this document is valid in the day of its preparation. Change of the product, as long as it does not affect the basic features of it, does not require consistent updates of the document.	page 2/12 general informations
-------	-----------------------------------	---	--

Ogi desk worktops

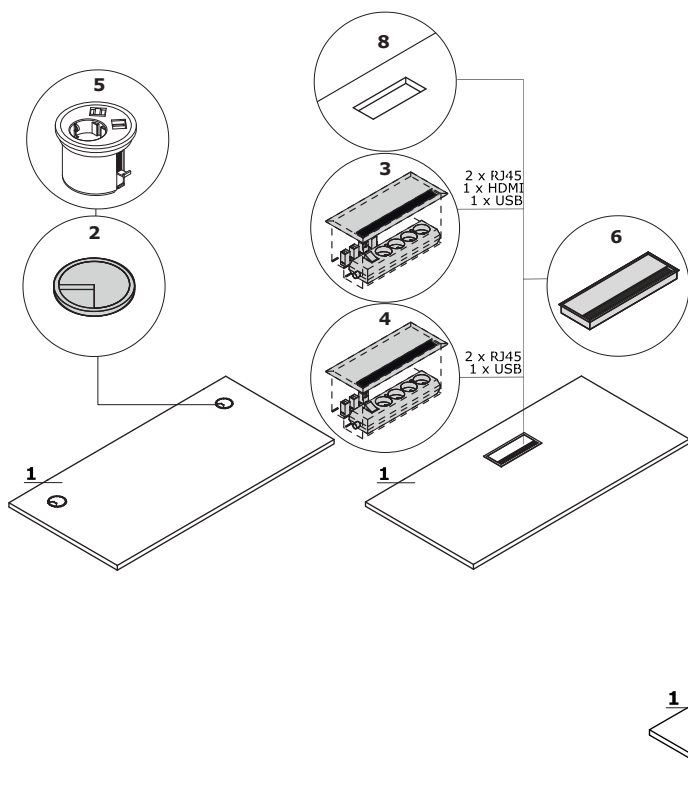

- 1. **Worktop** - MFC 28 mm, ABS edge
- OPTIONS WITH EXTRA CHARGE:**
- 2. **Grommet** - 2 pcs, Ø 80 mm
- 3. **Mediabox M04H** - 2 x RJ45 (class E, cat. 6); + 1 x USB + 1 x HDMI + 4 x 230V, mediabox colour is matched to the colour of the frame
- 4. **Mediabox M04** - 2 x RJ45 (class E, cat. 6); + 1 x USB + 4 x 230V, mediabox colour is matched to the colour of the frame
- 5. **Mediabox M07** - 1 x 230V + 1 x USB charger + 1 x RJ45, colour: black, white, mounted instead of the existing grommet Ø80 mm (PK80)
- 6. **Top access M05** - top access colour is matched to the colour of the frame
- 7. **Cable way** - the width of the opening is proportional to the width of the worktop
- 8. **Mediabox cut - out** - mediabox has to be selected separately

Frame

Ogi M: metal, powder coated, profile 40 × 40 mm, spacer 10 mm between top and frame

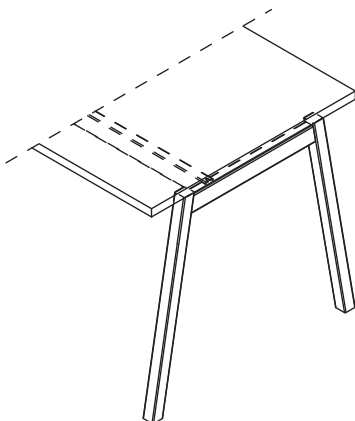

Attention - the cable tray located underneath the worktop is only available in: M009 - aluminium semi-matte colour

Ogi M	Date of preparation 30.11.2021	The data contained in this document is valid in the day of its preparation. Change of the product, as long as it does not affect the basic features of it, does not require consistent updates of the document.	page 3/12 technical description
-------	-----------------------------------	---	---

Desk with managerial storage

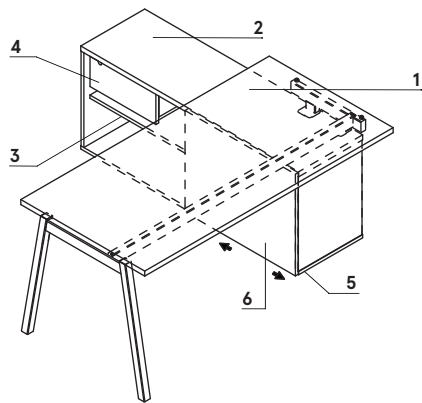

1. **Worktop** - MFC 28 mm, ABS edge
2. **Top** - MFC 28 mm, ABS edge
3. **Shelf** - MFC 18 mm, protection against accidental falling-out, ABS edge
4. **Drawer** - MFC 18 mm, ABS edge, patent lock - possible to change location
5. **Base** - MFC 18 mm, ABS edge
6. **Front** - MFC 18 mm, ABS edge

Configuration examples (mm)

www.mdd.eu

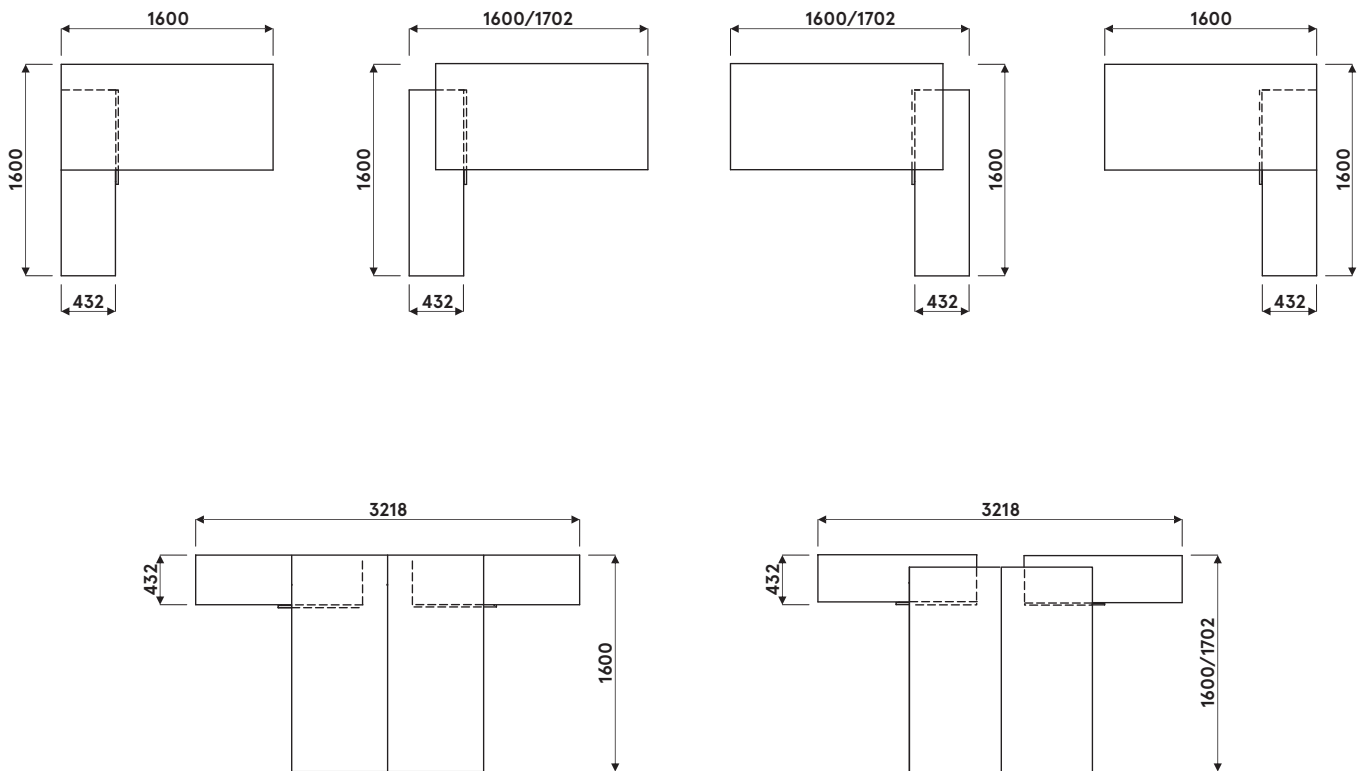

Configuration examples with BOX40, BOX50, BOX60

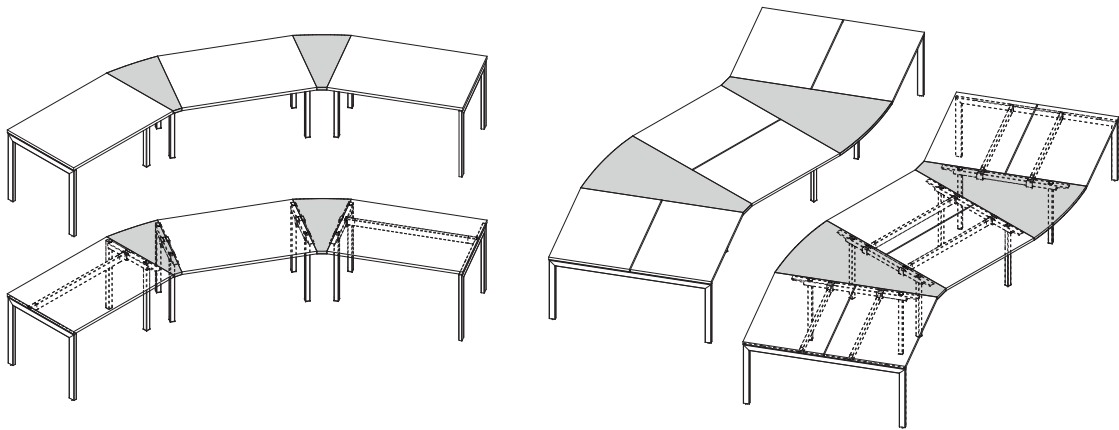

ATTENTION – only for Ogi Q, Ogi U, Ogi Y, Ogi M

Accessories

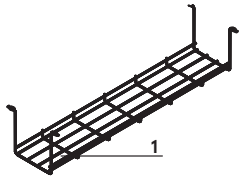

- 1. Horizontal cable tray S69 – powder coated, colour: 09 – aluminum
- 2. Single desk horizontal cable tray (SG12, SG16) – powder coated metal, colour: M009 – aluminum semi-matt
- 3. Horizontal cable tray E64 – powder coated, colour: M009 – aluminium semi-matt
- 4. Cable tray for bench desks (SG220, SG260) – steel wire Ø4 mm, powder coated, colour: 09 – aluminum

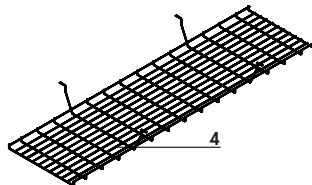
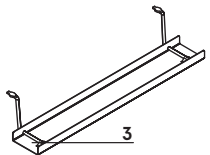
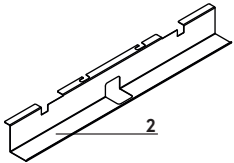

www.mdd.eu

Sliding top

- 1. Sliding top – shifting range 141 mm

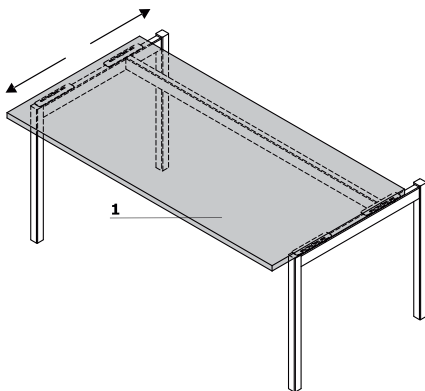

Note – M04, M04H, and M07 mediaboxes cannot be installed.

Ogi M	Date of preparation 30.11.2021	The data contained in this document is valid in the day of its preparation. Change of the product, as long as it does not affect the basic features of it, does not require consistent updates of the document.	page 5/12 technical description
-------	-----------------------------------	---	------------------------------------

Power strip - for series connection

- 1. **PWS1** - set for 1 workstation - power strip (3x SCHUCKO, 2x RJ45) x1 + power cord (universal outlet PL/FR/Schucko)
- 2. **PWS2** - set for 2 workstation - power strip (3x SCHUCKO, 2x RJ45) x2 + set of power cords (universal outlet PL/FR/Schucko)
- 3. **PWS3** - set for 3 workstation - power strip (3x SCHUCKO, 2x RJ45) x3 + set of power cords (universal outlet PL/FR/Schucko)

1

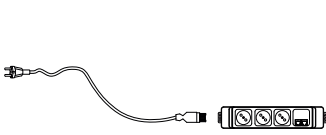

2

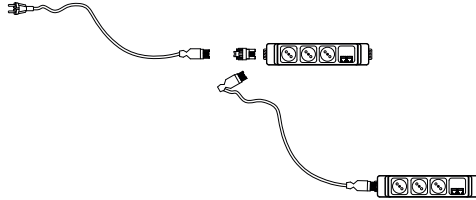

3

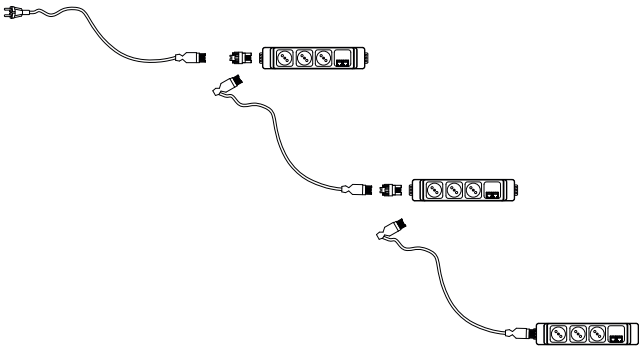

Desks *



BOM10
1000 / 600 / 740
24.3 kg



BOM12
1200 / 600 / 740
26.3 kg



BOM14
1400 / 600 / 740
29 kg

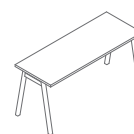

BOM16
1600 / 600 / 740
32.5 kg



BOM19
1000 / 700 / 740
24.3 kg



BOM22
1200 / 700 / 740
32 kg



BOM24
1400 / 700 / 740
33.6 kg



BOM26
1600 / 700 / 740
37.15 kg



BOM02
1200 / 800 / 740
35 kg



BOM03
1400 / 800 / 740
37.5 kg



BOM04
1600 / 800 / 740
42.55 kg



BOM05
1800 / 800 / 740
46.55 kg

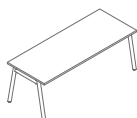

BOM06
2000 / 800 / 740
47.95 kg

* dimensions expressed in millimeters: width x depth x height

Elements for arrangement building - straight desk *

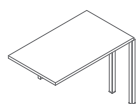

BOX10
1000 / 600 / 740
20.7 kg

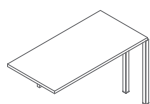

BOX12
1200 / 600 / 740
22.7 kg

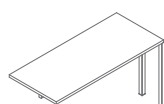

BOX14
1400 / 600 / 740
25.4 kg

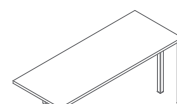

BOX16
1600 / 600 / 740
28.9 kg

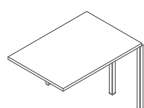

BOX30
1000 / 700 / 740
20.7 kg

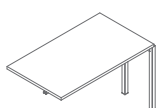

BOX32
1200 / 700 / 740
28.4 kg

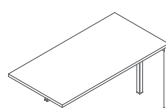

BOX34
1400 / 700 / 740
30 kg

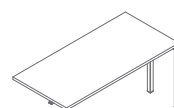

BOX36
1600 / 700 / 740
33.55 kg



BOX40
500 / 800 / 740
11 kg

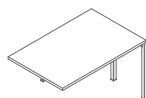

BOX42
1200 / 800 / 740
30.8 kg

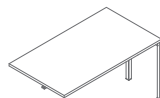

BOX43
1400 / 800 / 740
33.3 kg

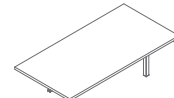

BOX44
1600 / 800 / 740
38.35 kg

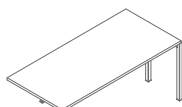

BOX45
1800 / 800 / 740
42.35 kg

* dimensions expressed in millimeters: width x depth x height

Bench desks *

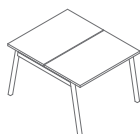

BOM50
1000 / 1210 / 740
42.6 kg

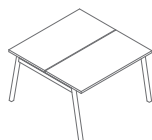

BOM52
1200 / 1210 / 740
46.6 kg

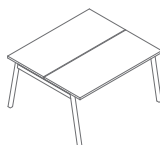

BOM54
1400 / 1210 / 740
52 kg



BOM56
1600 / 1210 / 740
59 kg

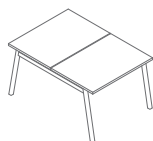

BOM48
1000 / 1410 / 740
43.6 kg

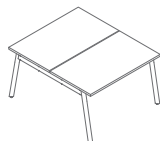

BOM42
1200 / 1410 / 740
59 kg

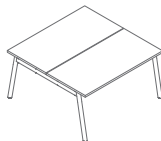

BOM44
1400 / 1410 / 740
62.2 kg



BOM46
1600 / 1410 / 740
69.3 kg

www.mdd.eu

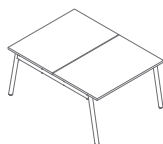

BOM32
1200 / 1610 / 740
64 kg

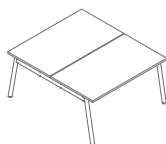

BOM33
1400 / 1610 / 740
69 kg

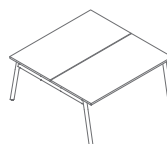

BOM34
1600 / 1610 / 740
79.1 kg

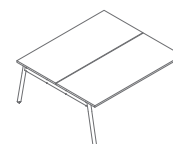

BOM35
1800 / 1610 / 740
87.1 kg

Elements for arrangement building - bench *

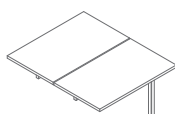

BOX20
1000 / 1210 / 740
36.6 kg

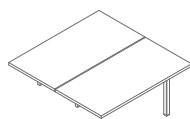

BOX22
1200 / 1210 / 740
40.6 kg

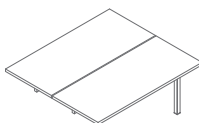

BOX24
1400 / 1210 / 740
46 kg

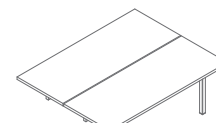

BOX26
1600 / 1210 / 740
53 kg

* dimensions expressed in millimeters: width x depth x height

Elements for arrangement building - bench *



BOX50
1000 / 1410 / 740
24.05 kg

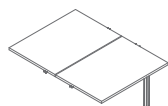

BOX51
1000 / 1410 / 740
38.2 kg

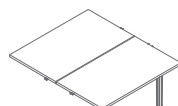

BOX52
1200 / 1410 / 740
53.6 kg

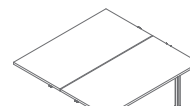

BOX54
1400 / 1410 / 740
56.8 kg

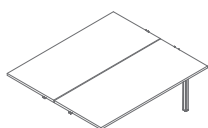

BOX56
1600 / 1410 / 740
63.9 kg

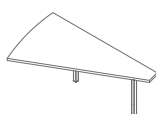

BOX60
1000 / 1610 / 740
28.75 kg

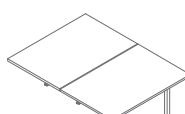

BOX62
1200 / 1610 / 740
58.35 kg

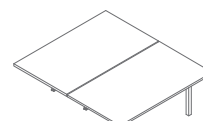

BOX64
1400 / 1610 / 740
63.35 kg

www.mdd.eu

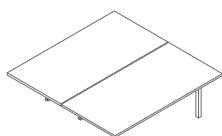

BOX66
1600 / 1610 / 740
73.45 kg

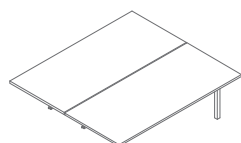

BOX68
1800 / 1610 / 740
81.45 kg

Desks with managerial storage *

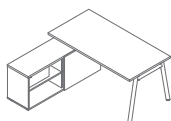

BOM20
1702-1600 / 1600 / 740
103.25 kg

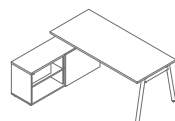

BOM21
1902-1800 / 1600 / 740
105.65 kg

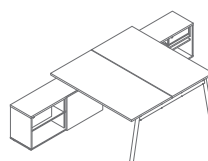

BOM40
1702-1600 / 3210 / 740
200.3 kg

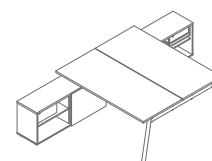

BOM41
1902-1800 / 3210 / 740
208.3 kg

* dimensions expressed in millimeters: width x depth x height

Ogi M	Date of preparation 30.11.2021	The data contained in this document is valid in the day of its preparation. Change of the product, as long as it does not affect the basic features of it, does not require consistent updates of the document.	page 10/12
			products

Desk extensions *

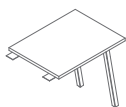

POM01
600 / 800 / 740
15.65 kg

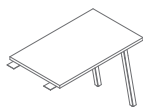

POM02
600 / 1000 / 740
16.65 kg

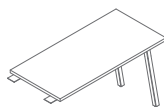

POM03
600 / 1200 / 740
18.65 kg

Power strip



PWS1
500 / 430 / 569
1.1 kg



PWS2
500 / 430 / 569
1.6 kg

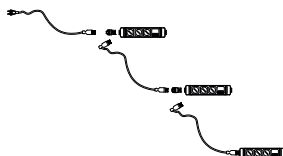

PWS3
500 / 430 / 569
2.1 kg

* dimensions expressed in millimeters: width x depth x height

Ogi M	Date of preparation 30.11.2021	The data contained in this document is valid in the day of its preparation. Change of the product, as long as it does not affect the basic features of it, does not require consistent updates of the document.	page 11/12
			products

Worktop



26 Aluminum satinato



31 Canadian oak *



39 Polar birch *



64 Cocoa *



168 Natural oak *



169 Honey oak*

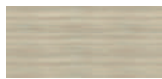

170 Acacia *



67 White pastel

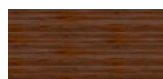

171 Dark walnut*

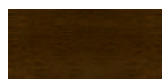

106 Lowland walnut *



154 Anthracite



08 Black



167 Grey oak *

Grommet



Aluminum



Beige



White



Black

Frame, mediabox - metal



M009 Aluminum semi-matt RAL9006



M015 White semi-matt RAL9010



M154 Antracite semi-matt RAL7043



M115 Black semi-matt RAL9005

* body - II group