

Ogi Drive - hand crank frame technical specification



.mdd

.mdd has a leading position among manufacturers of office furniture with many awards that prove quality and continuously increase demand for it's products.

The realities of today`s market require constant quality improvement at all levels of modern organization. This applies in particular to customer service, marketing, quality of products and also to quality of processes within the company. Partnership relations among employees and with business partners form a base of economic growth and success of the company.

Constant investments in innovative machinery park, optimization of management systems and an expansion of production halls allow to minimize the lead times for the product of the highest quality.

More than twenty years of experience in office furniture industry come with reference from a long list of companies and institutions to show their appreciation for an efficient and comprehensive service.

.mdd is higly aware of the environment.

Being located in the forest region with lake by itis side, .mdd takes the nature seriously and invests constantly in a modern and energy-efficient solutions to preserve the local life. Company puts emphasis on waste segregation and recycling. .mdd has been awarded for the exceptional care and involvement in waste disposal. All materials used are environmentally friendly and enjoy a high 95 % rate of being recycled.



General informations:

Warranty:

.mdd products – **5 years**.
Electrical components and fabric – **2 years**.

Certyficate - MFC:



Compliant with standards:

PN-EN 527-2:2017-02

Boards density:

12 mm - 690 - 750 kg/m³
18 mm - 650 - 690 kg/m³
28 mm - 610 - 630 kg/m³
36 mm - 610 - 630 kg/m³

Assembly:

product delivered in separate elements

Packing:

cardboard

Ogi desk worktops

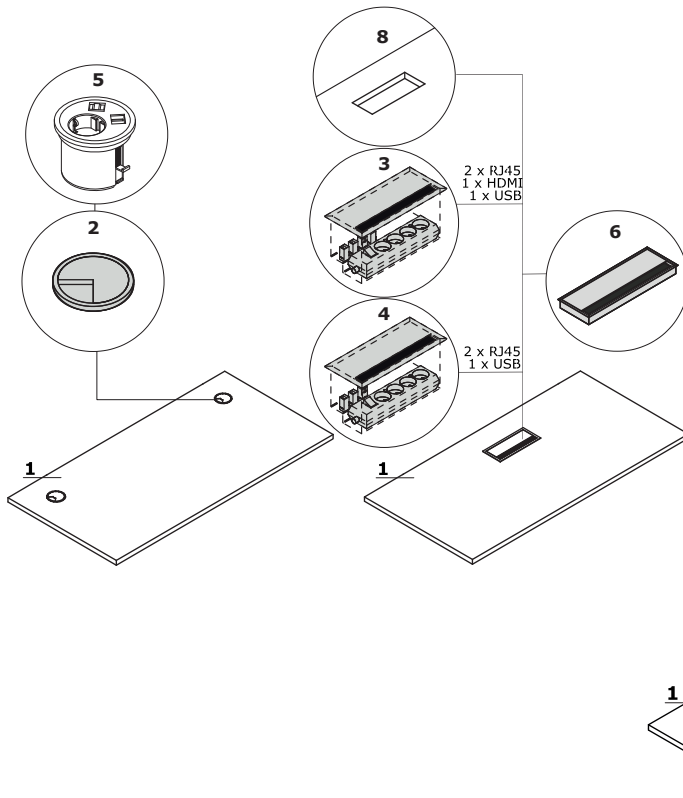

1. Worktop - MFC 28 mm, ABS edge

OPTIONS WITH EXTRA CHARGE:

- 2. Grommet - 2 pcs, Ø 80 mm
- 3. Mediabox M04H - 2 x RJ45 (class E, cat. 6); + 1 x USB + 1 x HDMI + 4 x 230V, mediabox colour is matched to the colour of the frame
- 4. Mediabox M04 - 2 x RJ45 (class E, cat. 6); + 1 x USB + 4 x 230V, mediabox colour is matched to the colour of the frame
- 5. Mediabox M07 - 1 x 230V + 1 x USB charger + 1 x RJ45, colour: black, white, mounted instead of the existing grommet Ø80 mm (PK80)
- 6. Top access M05 - top access colour is matched to the colour of the frame
- 7. Cable way - the width of the opening is proportional to the width of the worktop
- 8. Mediabox cut - out - mediabox has to be selected separately

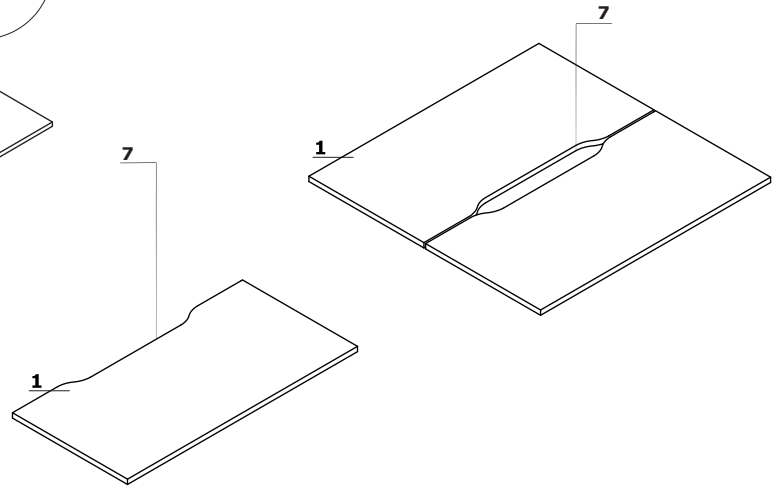

Frame

1. Ogi Drive with manual height adjustment - metal, powder coated, 2 profiles 50x50 mm i 60x60 mm, adjustment in the range of 650-1000 mm

2. OPTION WITH EXTRA CHARGE - Pro foot:

- aluminium powder coated
- polished aluminium

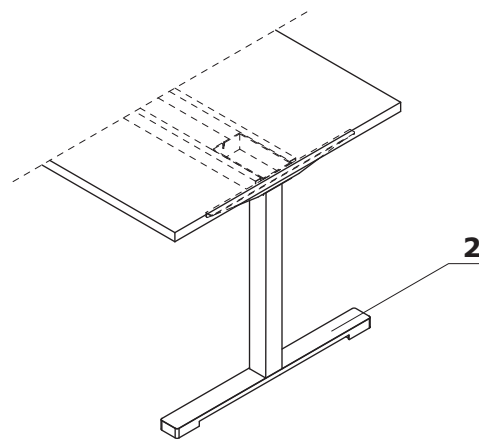
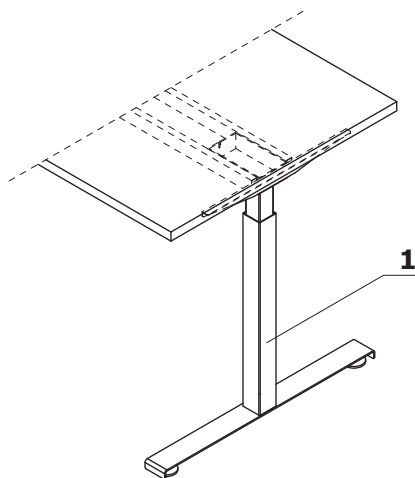

Hand crankframe - Ogi Drive

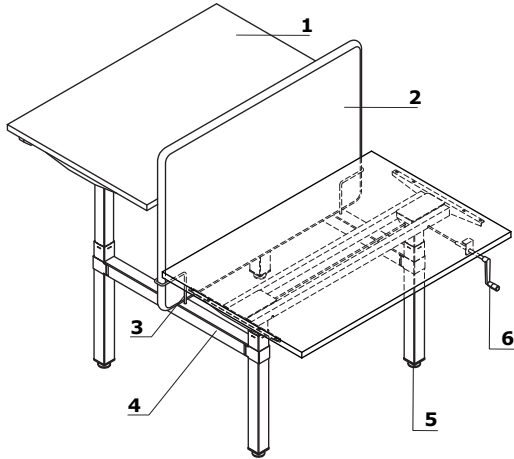

1. **Worktop** - MFC 28 mm, ABS edge
2. **ZD Panel** - acoustic class A, fire resistant, zip fastener, pinable
3. **Fixing element** - powder coated metal
4. **Metal element for legs connecting**
5. **Leveling feet** - range 5 mm
6. **Hand crank** - hidden handle, colour: black, stepless adjustment in the range of 650 - 1000 mm, rotation 2,25 mm, profiles 60 x 60 mm, 50 x 50 mm

Accessories

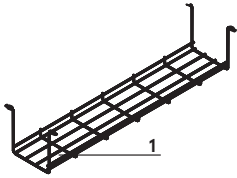

1. **Horizontal cable tray S69** - powder coated, colour: 09 - aluminum
2. **Single desk horizontal cable tray (SG12, SG16)** - powder coated metal, colour: M009 - aluminum semi-matt
3. **Horizontal cable tray E64** - powder coated, colour: M009 - aluminium semi-matt
4. **Cable tray for bench desks Ogi Drive (SOD12, SOD14, SOD16, SOD18, SOD20)** - powder coated, colour: M009 - aluminium semi-matt

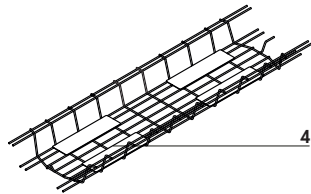
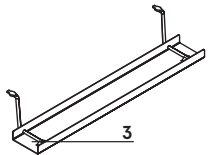
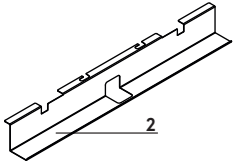

Single desks with hand crank adjustment in the range of 650- 1000 mm - sit-sit *



BOC02
1200 / 800 / 650-1000
45.1 kg



BOC03
1400 / 800 / 650-1000
49.6 kg

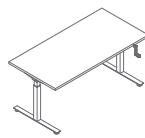

BOC04
1600 / 800 / 650-1000
52.5 kg

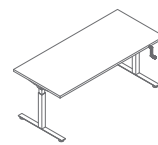

BOC05
1800 / 800 / 650-1000
55.4 kg

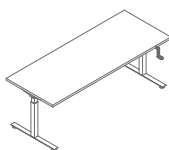

BOC06
2000 / 800 / 650-1000
72.15 kg

Bench desks with hand crank adjustment in the range of 650- 1000 mm - sit-sit *

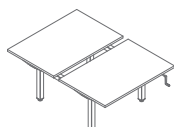

BOC20
1200 / 1690 / 650-1000
91.7 kg

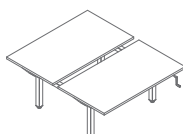

BOC30
1400 / 1690 / 650-1000
100.2 kg

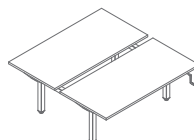

BOC40
1600 / 1690 / 650-1000
105.5 kg

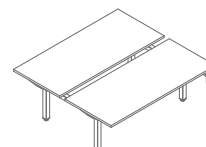

BOC50
1800 / 1690 / 650-1000
110.8 kg

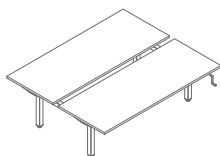

BOC60
2000 / 1690 / 650-1000
117.8 kg

* dimensions expressed in millimeters: width x depth x height

Worktop



26 Aluminum satinato



31 Canadian oak *



39 Polar birch *



64 Cocoa *



168 Natural oak *

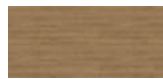

169 Honey oak*

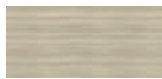

170 Acacia *



67 White pastel

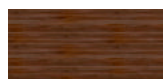

171 Dark walnut*

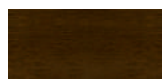

106 Lowland walnut *



154 Anthracite



08 Black



167 Grey oak *

Grommet



Aluminum



Beige



White



Black

Frame, mediabox - metal



M009 Aluminum semi-matt RAL9006



M015 White semi-matt RAL9010



M154 Antracite semi-matt RAL7043



M115 Black semi-matt RAL9005