

Meeting tables Ogi W technical specification



.mdd

.mdd has a leading position among manufacturers of office furniture with many awards that prove quality and continuously increase demand for its products.

The realities of today's market require constant quality improvement at all levels of modern organization. This applies in particular to customer service, marketing, quality of products and also to quality of processes within the company.

Partnership relations among employees and with business partners form a base of economic growth and success of the company.

Constant investments in innovative machinery park, optimization of management systems and an expansion of production halls allow to minimize the lead times for the product of the highest quality.

More than twenty years of experience in office furniture industry come with reference from a long list of companies and institutions to show their appreciation for an efficient and comprehensive service. .mdd is highly aware of the environment.

Being located in the forest region with lake by its side, .mdd takes the nature seriously and invests constantly in a modern and energy-efficient solutions to preserve the local life. Company puts emphasis on waste segregation and recycling. .mdd has been awarded for the exceptional care and involvement in waste disposal. All materials used are environmentally friendly and enjoy a high 95 % rate of being recycled.



General informations:

Warranty:

.mdd products - **5 years**.

Electrical components and fabric - **2 years**.

Certificate - MFC:



Assembly:

product delivered in separate elements

Packing:

cartboard, perforated plastic mesh wrap

Compliant with standards:

PN-EN 15372:2010

Boards density:

12 mm - 690 - 750 kg/m³

18 mm - 650 - 690 kg/m³

28 mm - 610 - 630 kg/m³

36 mm - 610 - 630 kg/m³

Worktop

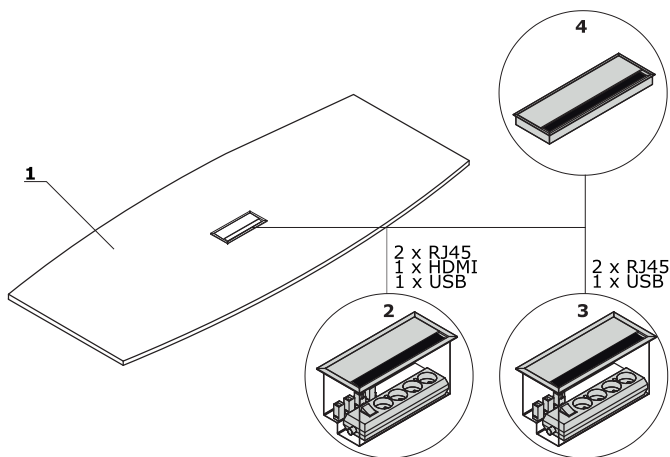

- 1. **Worktop** - MFC 28 mm, ABS edge
- OPTIONS WITH EXTRA CHARGE:**
- 2. **Mediabox M04H** - 2xRJ45 (class E, cat. 6); +1 x USB + 1 x HDMI + 4x 230V, colour: M009 - aluminium semi-matt
- 3. **Mediabox M04** - 2xRJ45 (class E, cat. 6); +1 x USB + 4x 230V, colour: M009 - aluminium semi-matt
- 4. **Top access M05** - colour: M009 - aluminium semi-matt

Frame - meeting tables Ogi W

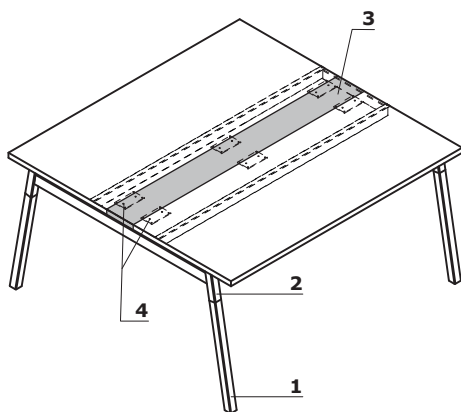

- 1. **Frame** - metal frame , profile 50 × 50 mm, wooden leg - ash natural
- 2. **Metal element** - powder coated
- 3. **MFC element** - matches with frame colour; without mediabox as standard
- 4. **Fixing flat bar**

Conference tables - Ogi W *

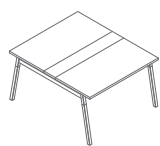

SW42
1200 / 1410 / 740
51 kg

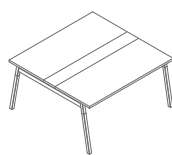

SW44
1400 / 1410 / 740
57 kg

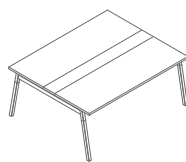

SW46
1600 / 1410 / 740
63.2 kg

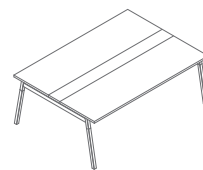

SW48
1800 / 1410 / 740
72 kg

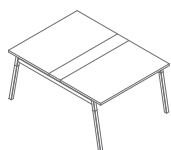

SW32
1200 / 1610 / 740
57 kg

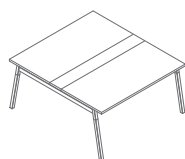

SW33
1400 / 1610 / 740
64 kg

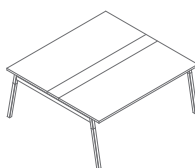

SW34
1600 / 1610 / 740
71.2 kg

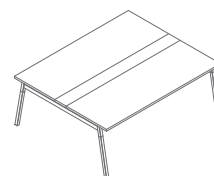

SW35
1800 / 1610 / 740
79 kg

Elements for pairing - Ogi W *

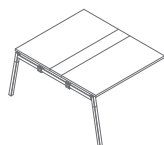

SW42L
1200 / 1410 / 740
45.2 kg

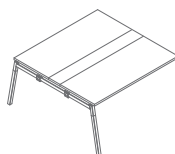

SW44L
1400 / 1410 / 740
51.2 kg

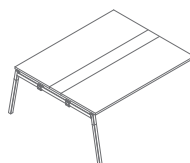

SW46L
1600 / 1410 / 740
57.4 kg

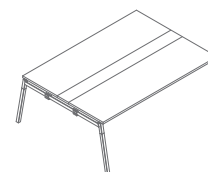

SW48L
1800 / 1410 / 740
66.2 kg

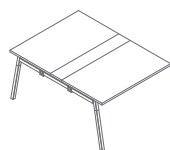

SW32L
1200 / 1610 / 740
50.8 kg

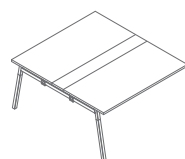

SW33L
1400 / 1610 / 740
57.8 kg

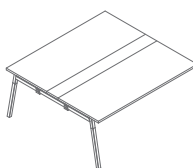

SW34L
1600 / 1610 / 740
65 kg

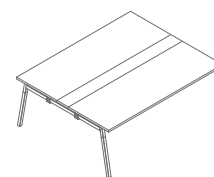

SW35L
1800 / 1610 / 740
72.8 kg

* dimensions expressed in millimeters: width x depth x height

Top



Frame

