

Meeting tables Ogi A technical specification



.mdd

.mdd has a leading position among manufacturers of office furniture with many awards that prove quality and continuously increase demand for its products.

The realities of today's market require constant quality improvement at all levels of modern organization. This applies in particular to customer service, marketing, quality of products and also to quality of processes within the company.

Partnership relations among employees and with business partners form a base of economic growth and success of the company.

Constant investments in innovative machinery park, optimization of management systems and an expansion of production halls allow to minimize the lead times for the product of the highest quality.

More than twenty years of experience in office furniture industry come with reference from a long list of companies and institutions to show their appreciation for an efficient and comprehensive service.

MDD is highly aware of the environment.

Being located in the forest region with lake by its side, .mdd takes the nature seriously and invests constantly in a modern and energy-efficient solutions to preserve the local life. Company puts emphasis on waste segregation and recycling. .mdd has been awarded for the exceptional care and involvement in waste disposal. All materials used are environmentally friendly and enjoy a high 95 % rate of being recycled.



General informations:

Warranty:

.mdd products - **5 years.**

Electrical components and fabric - **2 years.**

Certificate - MFC:



Compliant with standards:

PN-EN 15372:2010

Boards density:

12 mm - 690 - 750 kg/m³

18 mm - 650 - 690 kg/m³

28 mm - 610 - 630 kg/m³

36 mm - 610 - 630 kg/m³

Assembly:

product delivered in separate elements

Packing:

cartboard, perforated plastic mesh wrap

Worktop

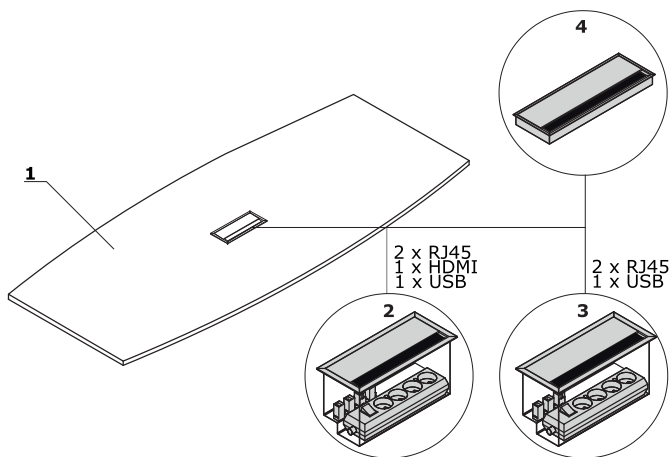

- 1. **Worktop** - MFC 28 mm, ABS edge
- OPTIONS WITH EXTRA CHARGE:**
- 2. **Mediabox M04H** - 2xRJ45 (class E, cat. 6); +1 x USB + 1 x HDMI + 4x 230V, colour: M009 - aluminium semi-matt
- 3. **Mediabox M04** - 2xRJ45 (class E, cat. 6); +1 x USB + 4x 230V, colour: M009 - aluminium semi-matt
- 4. **Top access M05** - colour: M009 - aluminium semi-matt

Frame - meeting tables Ogi A

- 1. **Leg** - powder coated steel, profile 60x30 mm
- 2. **Leveling** - 5 mm range
- 3. **Supporting leg NG41** - powder coated steel

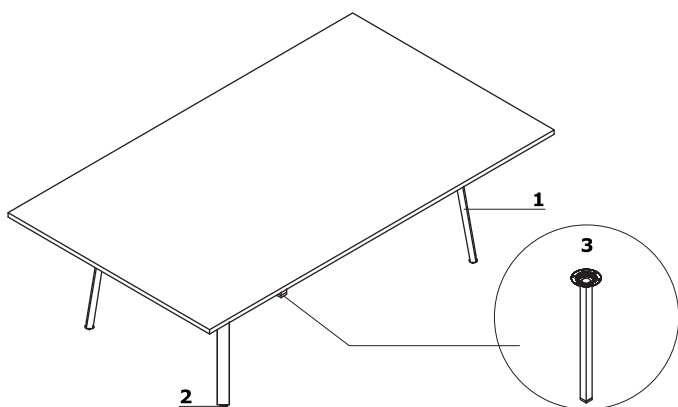

Meeting tables Ogi A *



PLF80
800 / 800 / 740
17 kg



PLF10
1000 / 1000 / 740
24 kg



PLF11
1200 / 1200 / 740
28 kg

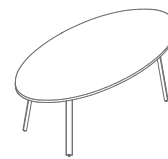

PLF12E
2000 / 1000 / 740
42 kg



PLF81
800 / 800 / 740
20 kg

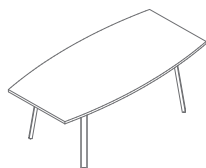

PLF12P
2000 / 800-1000 / 740
43 kg

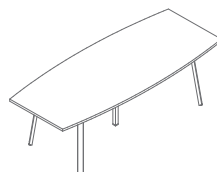

PLF24
2400 / 800-1000 / 740
50 kg

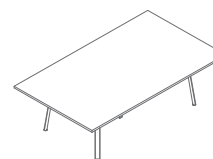

PLF25
2400 / 1400 / 740
73 kg



PLF14P
1400 / 800-1100 / 740
41.7 kg



PLF14S
1400 / 1100 / 740
39.9 kg



PLF14L
1400 / 800-1100 / 740
30.2 kg

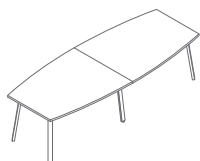

PLF18
2000 / 1100-800 / 740
71.9 kg

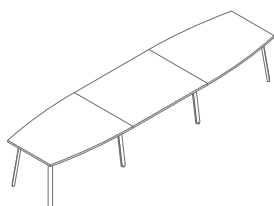

PLF19
4200 / 1100*800 / 740
111.8 kg

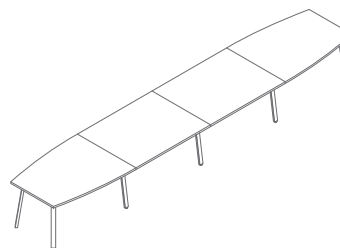

PLF20
5600 / 1100-800 / 740
151.7 kg

* dimensions expressed in millimeters: width x depth x height

Meeting tables Ogi A *

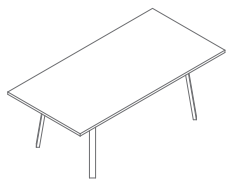

PLF12PK
2000 / 800-1000 / 740
45 kg

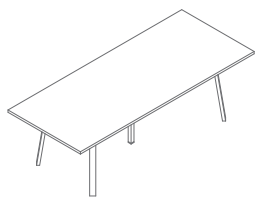

PLF24K
2400 / 800-1000 / 740
54.5 kg

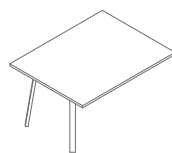

PLF14LK
1400 / 800-1000 / 740
32.7 kg

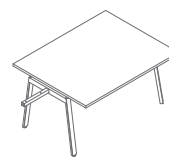

PLF14PK
1400 / 800-1000 / 740
44.2 kg

Low tables Ogi A *



PLF82
800 / 800 / 550
15.5 kg



PLF60
600 / 600 / 550
11 kg

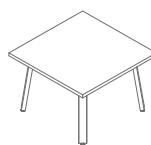

PLF83
800 / 800 / 550
18 kg



PLF61
600 / 600 / 550
13 kg

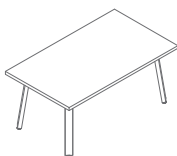





PLF17
1200 / 700 / 550
21.5 kg

* dimensions expressed in millimeters: width x depth x height

Top

			
14 Beech	26 Aluminum satinato	31 Canadian oak	34 Chestnut
			
39 Polar birch	64 Cocoa	67 White pastel	106 Lowland walnut
			
154 Anthracite	08 Black	167 Grey oak	168 Natural oak

Frame

			
M009 Aluminum semi-mat RAL9006	M015 White semi-mat RAL9010	M154 Anthracite semi-mat RAL7043	M115 Black semi-mat RAL9005