

Folding tables Easy technical specification



.mdd

.mdd has a leading position among manufacturers of office furniture with many awards that prove quality and continuously increase demand for it's products.

The realities of today`s market require constant quality improvement at all levels of modern organization. This applies in particular to customer service, marketing, quality of products and also to quality of processes within the company.

Partnership relations among employees and with business partners form a base of economic growth and success of the company.

Constant investments in innovative machinery park, optimization of management systems and an expansion of production halls allow to minimize the lead times for the product of the highest quality.

More than twenty years of experience in office furniture industry come with reference from a long list of companies and institutions to show their appreciation for an efficient and comprehensive service. .mdd is highly aware of the environment.

Being located in the forest region with lake by it's side, .mdd takes the nature seriously and invests constantly in a modern and energy-efficient solutions to preserve the local life. Company puts emphasis on waste segregation and recycling. .mdd has been awarded for the exceptional care and involvement in waste disposal. All materials used are environmentally friendly and enjoy a high 95 % rate of being recycled.



General informations:

Warranty:

.mdd products - **5 years.**

Electrical components and fabric - **2 years.**

Certificate - MFC:



Boards density:

12 mm - 690 - 750 kg/m³

18 mm - 650 - 690 kg/m³

28 mm - 610 - 630 kg/m³

36 mm - 610 - 630 kg/m³

Assembly:

product delivered in separate elements

Packing:

cartboard

Folding tables Easy

1. **Worktop** - MFC 28 mm, ABS edge
2. **Frame** - metal, powder coated, profile Ø22 mm
3. **Joining rail** - metal, powder coated, colour: M009 - aluminum semi-matt, profile 40x20 mm
4. **Wheels with brake** - Ø65 mm
5. **Optional modesty panel US92** - MFC 18 mm, ordered separately
6. **Hook** - to connect tables
7. **Release button**
8. **Folding base** - chrome
9. **OPTION WITH EXTRA CHARGE** - Mediabox + horizontal cable tray:
 - Mediabox M08H - 2xRJ45 (class E, cat. 6); +1 x USB + 1 x HDMI + 4x 230V, mediabox colour is matched to the colour of the frame
 - Mediabox M08 - 2xRJ45 (class E, cat. 6); +1 x USB + 4x 230V, mediabox colour is matched to the colour of the frame

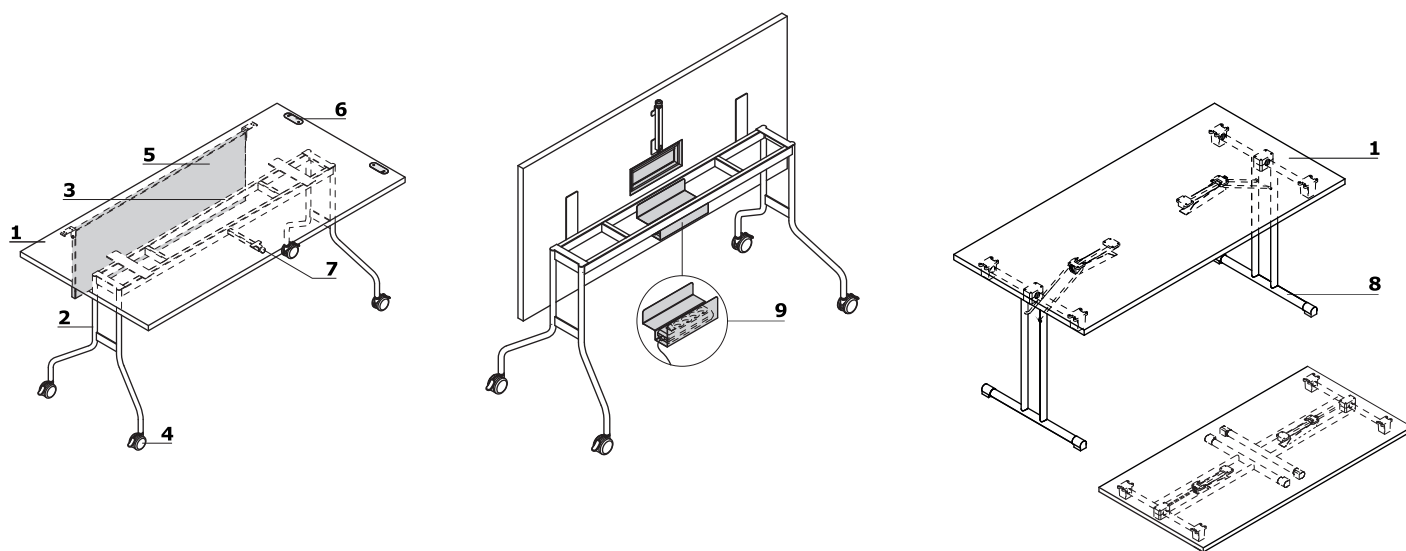

www.mdd.eu

Easy tables configurations

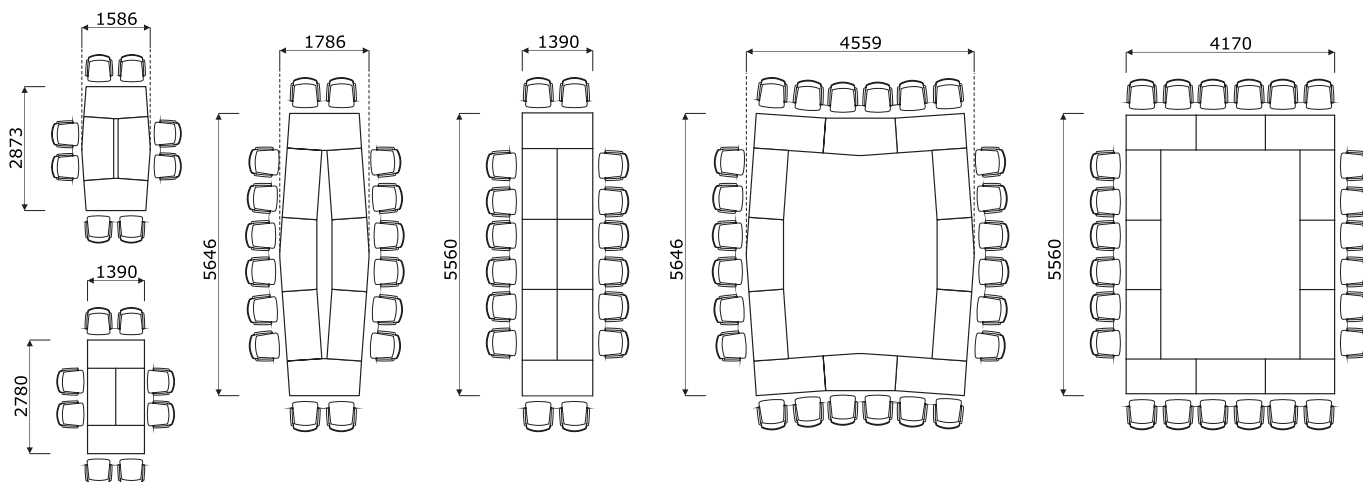

Chairs arrangement

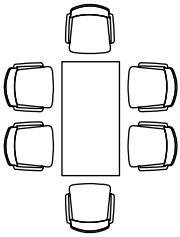

POG61

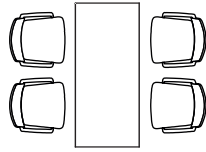

PFT03

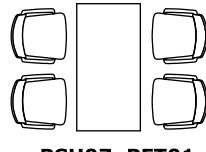

PSU07, PFT01

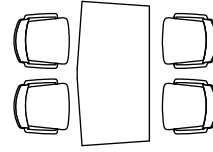

PFT02

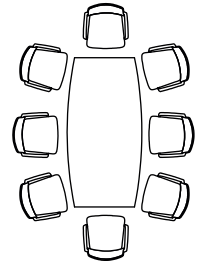

PA51, ST12P, BRN41,
PLF12P, PR41,
PR41R, POG41

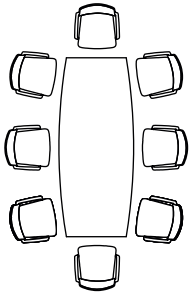

ST24, PR52, PR52R,
PLF24, POG52

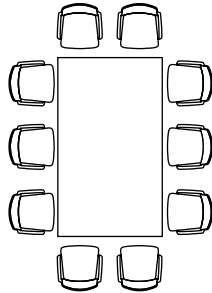

PLF25

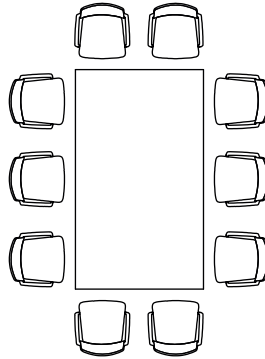

PLF25

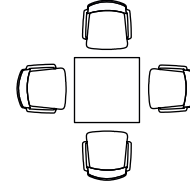

PLF81, PO27,
POG28, PR57

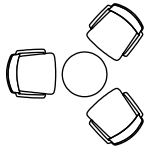

PS2

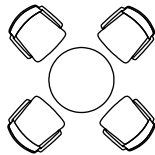

PLF80, ST08,
POG28, PR56, PO26

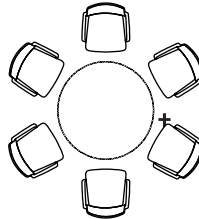

PLF11, ST12

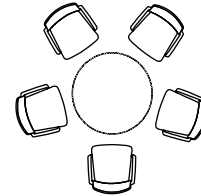

PLF10, ST10

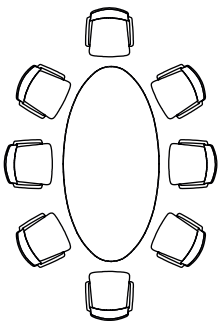

PLF12E, ST12E

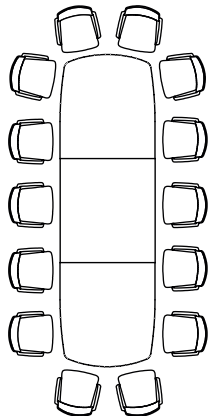

BUN24, BUN24S, BUN24P

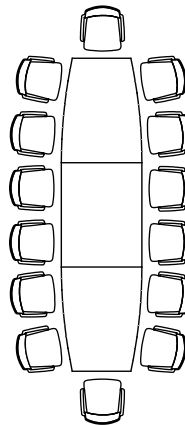

PLF14L, ST14, PLF14S,
ST14S, PLF14P, ST14

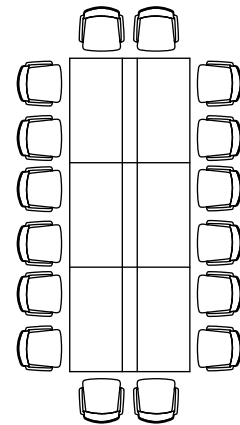

SY04 + 2x SY14

Folding tables *

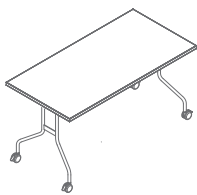

PFT01
1390 / 695 / 740
30.3 kg

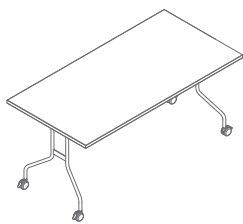

PFT03
1600 / 800 / 740
35.3 kg

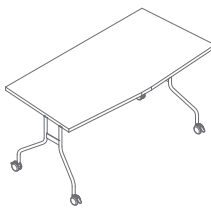

PFT02
1486 / 743 / 740
33.3 kg

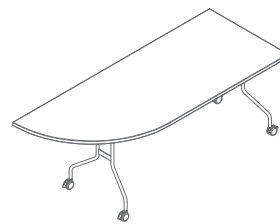

PFT04
2000 / 800 / 740
41.3 kg

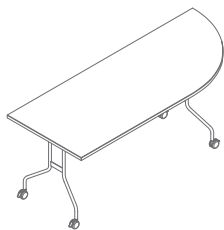

PFT05
2000 / 800 / 740
41.3 kg

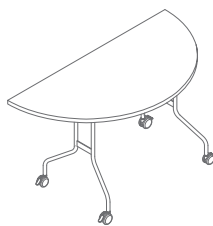

PFT06
695 / 1390 / 740
26.3 kg

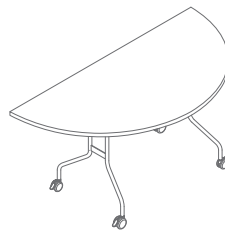

PFT07
800 / 1600 / 740
31.3 kg

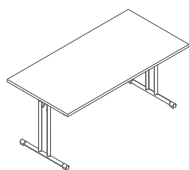

PSU07
1390 / 695 / 725
23 kg

MFC modesty screen *



US92
925 / 18 / 320
3.5 kg

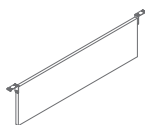

US93
1135 / 18 / 320
35.3 kg

* dimensions expressed in millimeters: width x depth x height

Top



Frame PFT

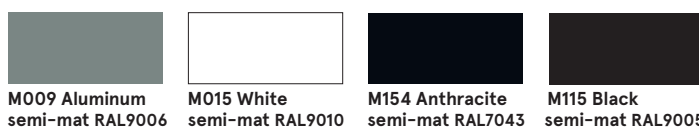

Frame PSU07

