

Hako technical specification



.mdd

MDD has a leading position among manufacturers of office furniture with many awards that prove quality and continuously increase demand for its products.

The realities of today's market require constant quality improvement at all levels of modern organization. This applies in particular to customer service, marketing, quality of products and also to quality of processes within the company.

Partnership relations among employees and with business partners form a base of economic growth and success of the company.

Constant investments in innovative machinery park, optimization of management systems and an expansion of production halls allow to minimize the lead times for the product of the highest quality.

More than twenty years of experience in office furniture industry come with reference from a long list of companies and institutions to show their appreciation for an efficient and comprehensive service.

MDD is highly aware of the environment.

Being located in the forest region with lake by its side, MDD takes the nature seriously and invests constantly in a modern and energy-efficient solutions to preserve the local life. Company puts emphasis on waste segregation and recycling. MDD has been awarded for the exceptional care and involvement in waste disposal. All materials used are environmentally friendly and enjoy a high 95 % rate of being recycled.



General informations:

Warranty:

MDD products - **5 years.**

Electrical components and fabric - **2 years.**

Boards density:

12 mm - 690 - 750 kg/m³

18 mm - 650 - 690 kg/m³

28 mm - 610 - 630 kg/m³

36 mm - 610 - 630 kg/m³

Certificate - MFC:



Certificate - fabric:



Assembly:

product delivered in separate elements

Packing:

wooden crates; separate elements situated on wooden racks; panels protected by a foil

Office booth Hako

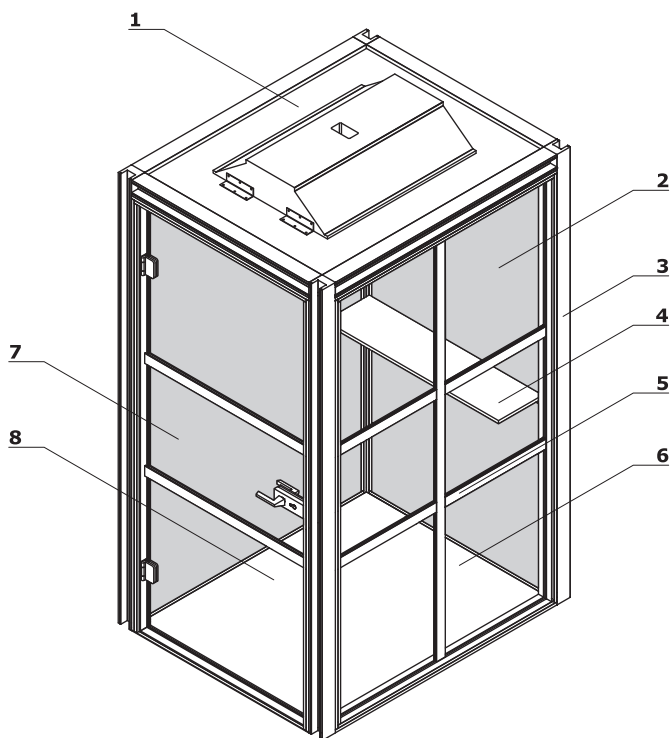

1. **Ceiling** - upholstered, equipped with lighting and ventilation system activated by:

- motion detector (A)
- wireless switch (B)

2. **Upholstered wall** - full, 75 mm thick, upholstered on both sides, acoustic properties

3. **Columns** - 75x75 mm, powder coated

4. **Shelf** - 12 mm MDF, colour: black, can be mounted only to upholstered walls with 1000 mm width

5. **Aluminium strips** - 5 mm thick

6. **Glass wall** - toughened glass, 6 mm thick

7. **Glass door** - toughened glass, 8 mm thick, equipped with hinges and gasket system that extends the acoustic properties of the booth

8. **OPTION WITH EXTRA CHARGE** - floor - melamine plate + acoustic covering (21 mm thickness), colour: graphite

Electric systems available:

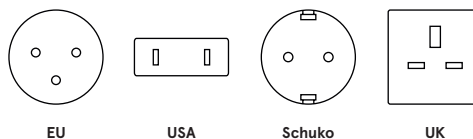

Additional information:

- walls - the highest class of acoustics, class A
- certificated Sonic technology used in acoustic panels
- air function - fans work for additional 5 minutes after leaving the booth
- LED SLIM panel, 60x60 cm, external power supply; 40W, 3200lm, 4000k, 220-240V AC, 120', RA>80, PF>0.9, white, STANDARD LINE

HK01

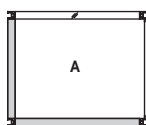

HK021

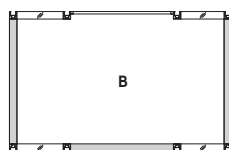

HK04

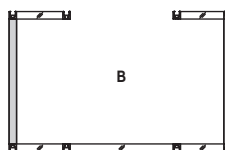

HK03

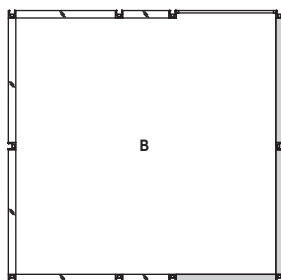

HK05

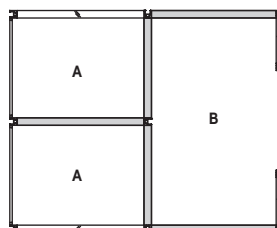

HK07

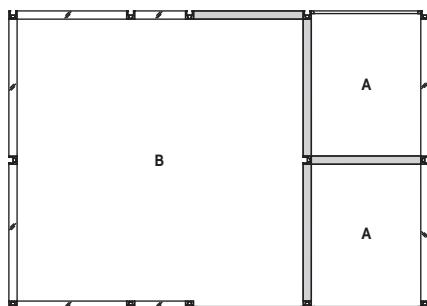

HK06

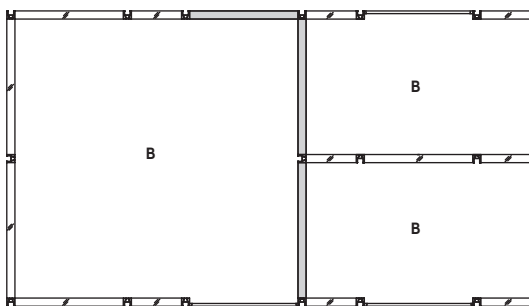

Attention! In standard the booth has no floor what allows, among other things, situating the booth in any place as well as easy cable management.

Hako	Date of preparation 20.12.2019	The data contained in this document is valid in the day of its preparation. Change of the product, as long as it does not affect the basic features of it, does not require consistent updates of the document.	page 3/9 technical specification
------	-----------------------------------	---	-------------------------------------

Configuration examples

HK01

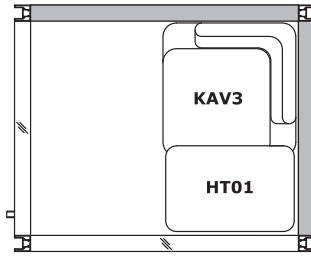
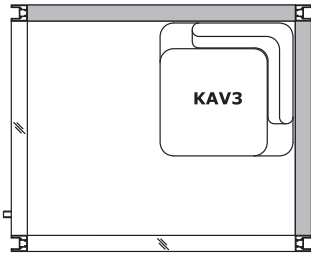

HK021

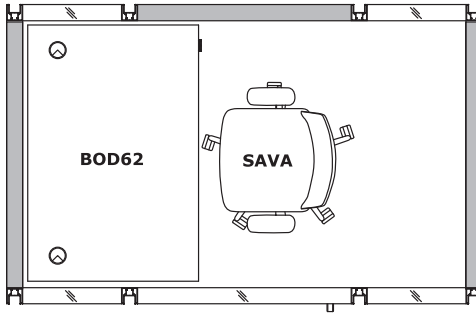
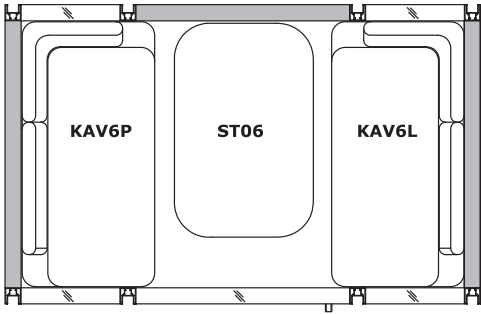

HK03

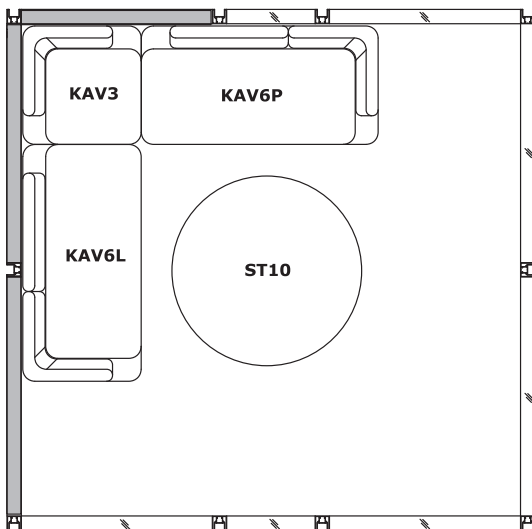
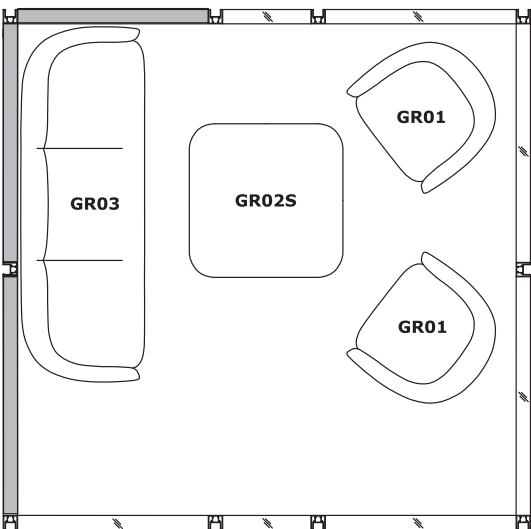
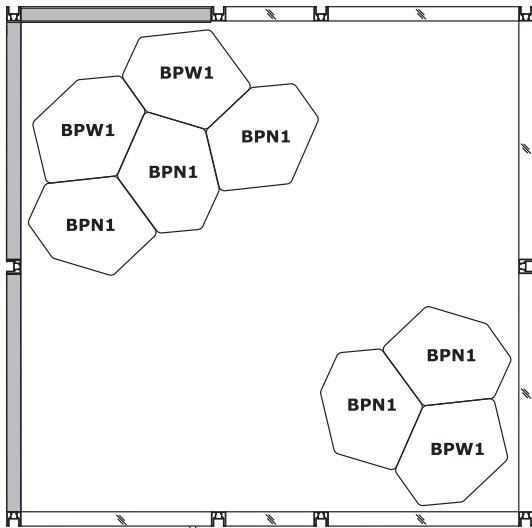
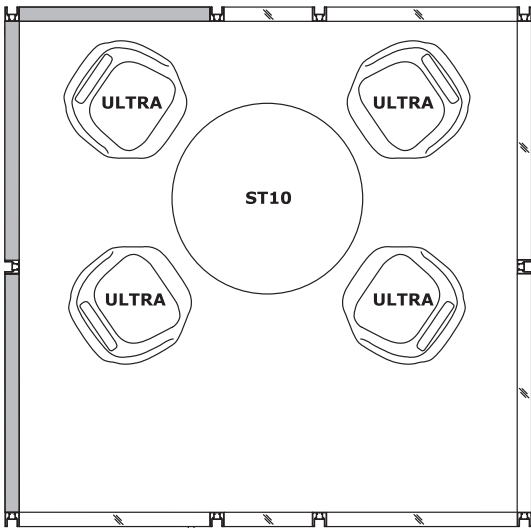

www.mdd.eu

Mediabox location

- A - on the left wall near the floor
- B - on the right wall near the floor
- C - on the shorter wall above 740mm height

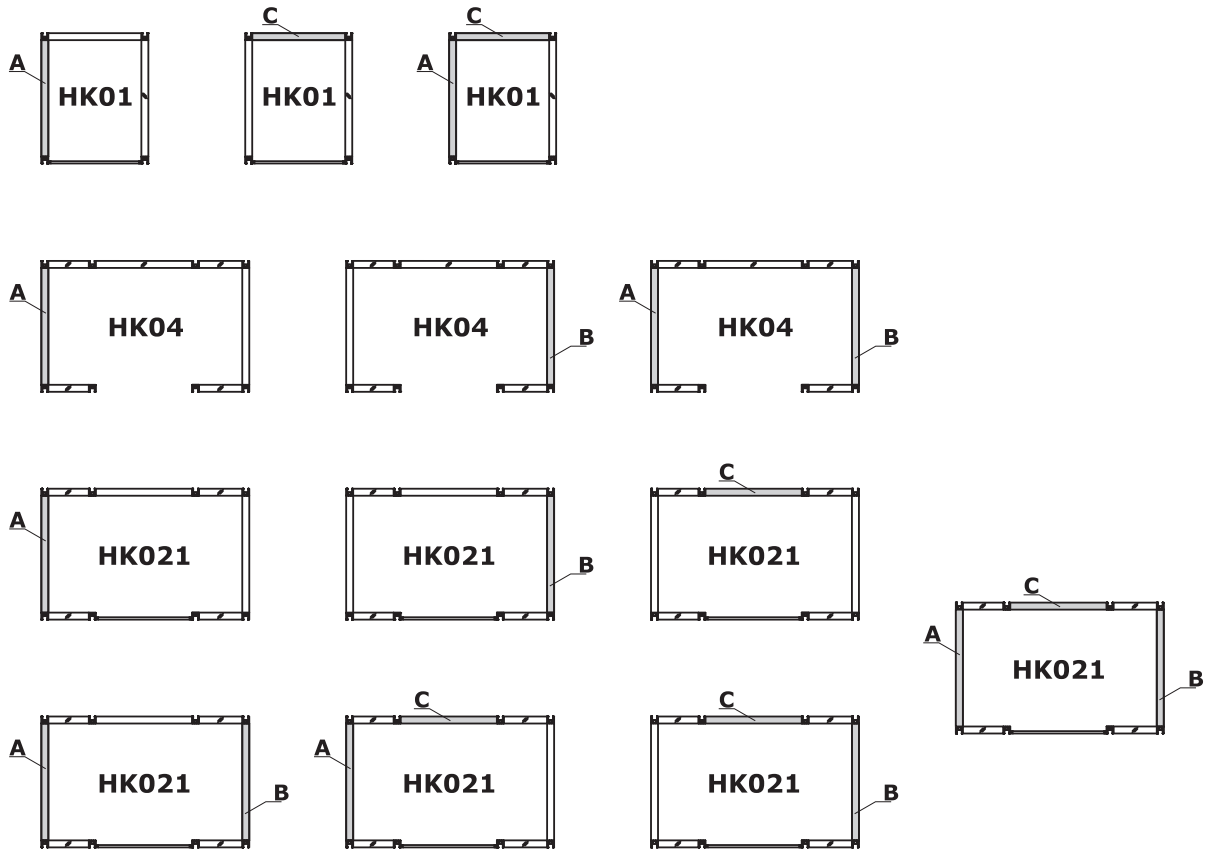

www.mdd.eu

Mediabox - dimensions (mm)

1. Mediabox - 2x230V + 1xUSB + 1xUSB type C

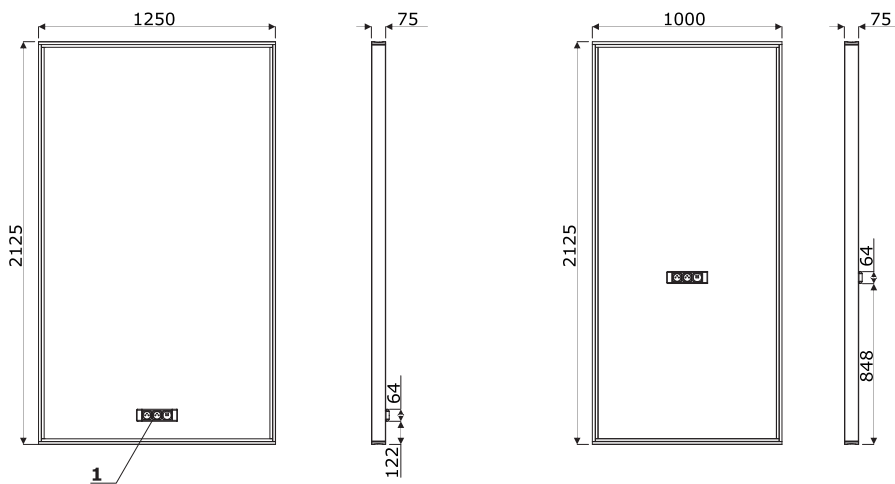

Dimensions

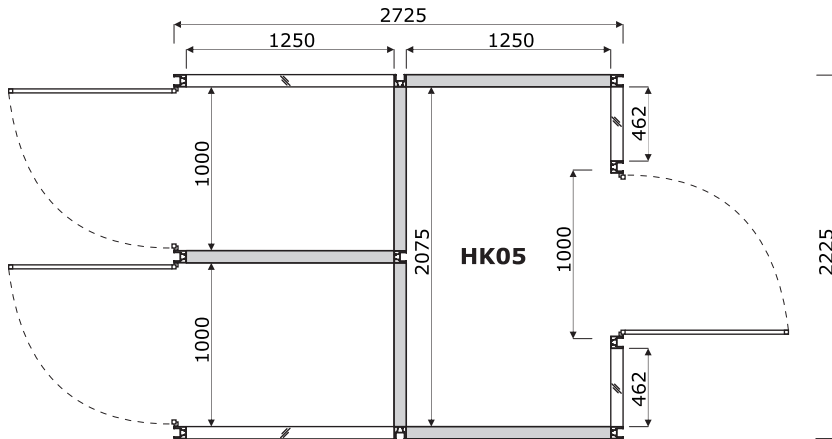
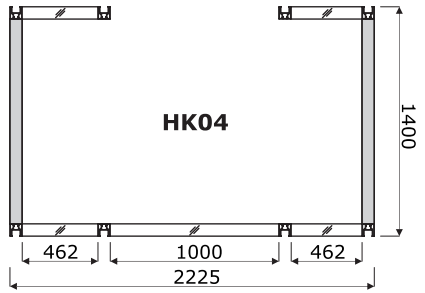
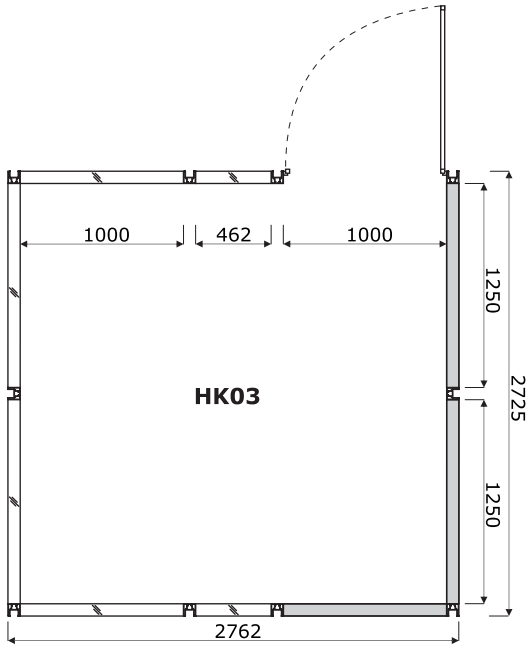
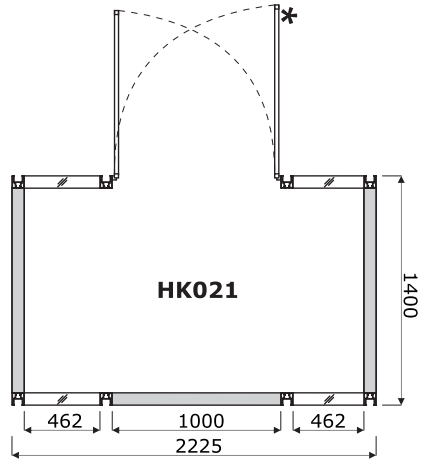
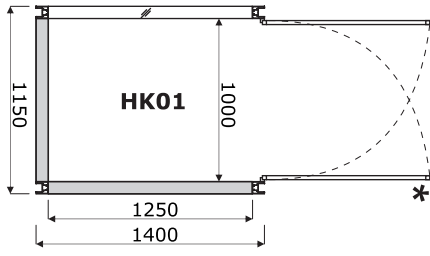

* left / right door option

Hako	Date of preparation 20.12.2019	The data contained in this document is valid in the day of its preparation. Change of the product, as long as it does not affect the basic features of it, does not require consistent updates of the document.	page 6/9
			dimensions (mm)

Dimensions

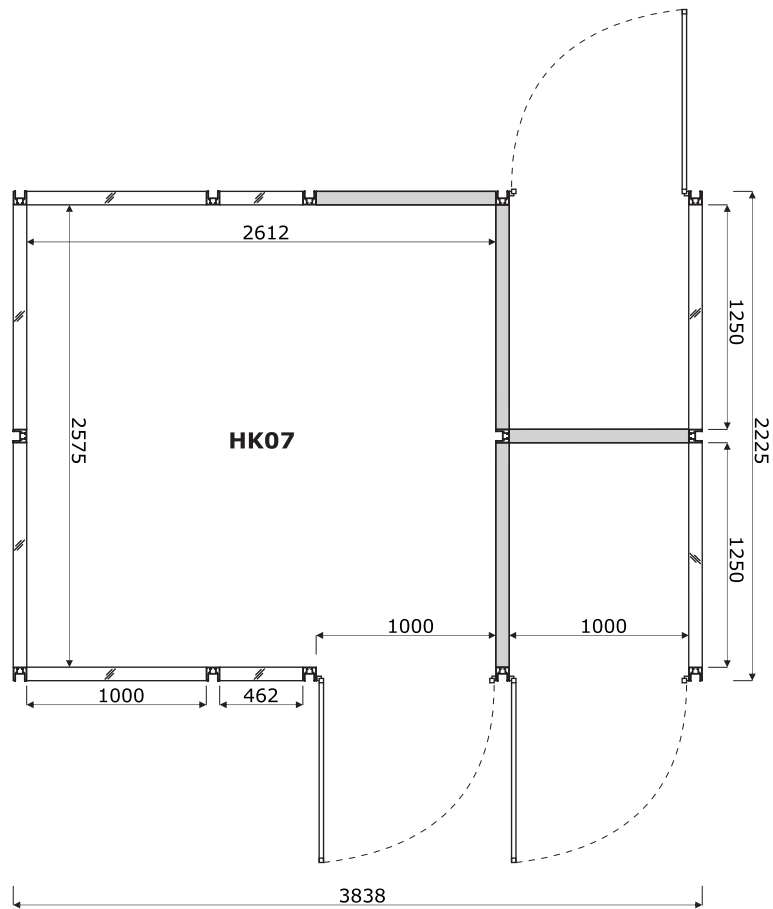
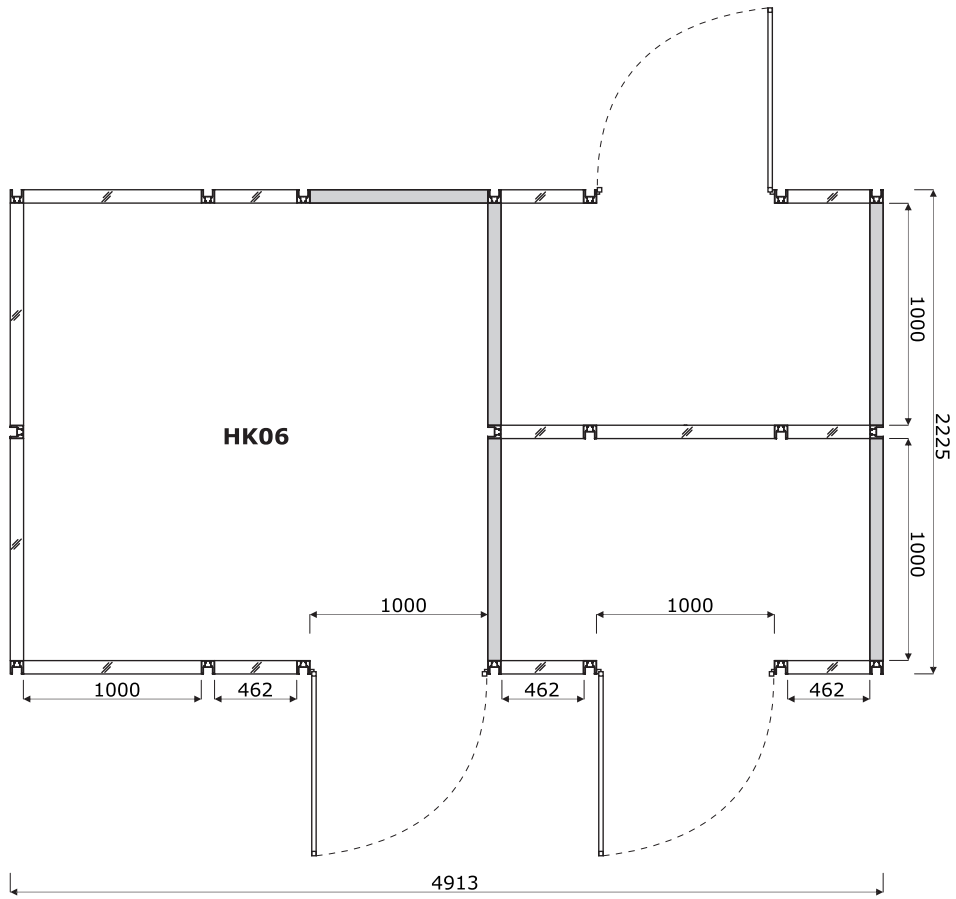

Hako - office booth *

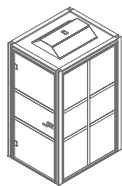

HK01
1400 / 1150 / 2341
398 kg

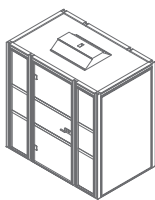

HK021
2225 / 1400 / 2341
531.18 kg

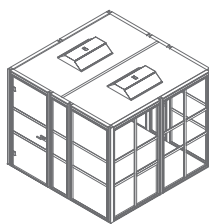

HK03
2762 / 2725 / 2341
935.3 kg

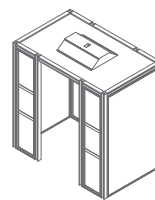

HK04
2225 / 1400 / 2341
442 kg

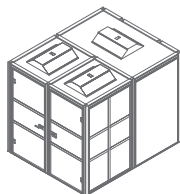

HK05
2725 / 2225 / 2341
1451.68 kg

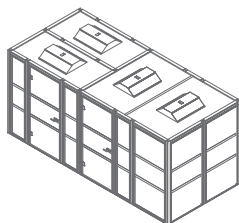

HK06
2225 / 4913 / 2341
1571 kg

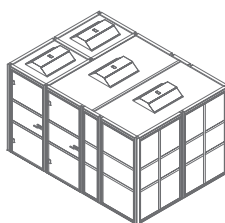

HK07
2725 / 3838 / 2341
1426.38 kg

Shelf *

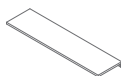

HK1P
980 / 250 / 156
6 kg

* dimensions expressed in millimeters: width x depth x height

Hako	Date of preparation 20.12.2019	The data contained in this document is valid in the day of its preparation. Change of the product, as long as it does not affect the basic features of it, does not require consistent updates of the document.	page 8/9
			products

Office booth – walls outside, inside – fabric Medley – second group



M-68005 Dark olive
M-68002 Light olive
M-68115 Green
M-61002 Beige
M-67053 Navy blue
M-67006 Light blue
M-66008 Grey
M-64019 Red
M-63064 Pink
M-60999 Black

Technical data:

Material polyester 100%
Fabric weight 510 g/lm (16.45 oz/lin.yd.)
Abrasion resistance rubs BS EN ISO 12947-2, 75,000 cykli Martindale
Pilling resistance scale 1-5, max. 5, EN ISO 12945-2 (4)
Colour fastness to light scale 1-8, max. 8, EN ISO 105-B02 (5-7)
Colour fastness to rubbing scale 1-5, max. 5, EN ISO 105x12 (wet/dry (4-5/4-5))
Acoustic test sound absorption ISO 354
Flammability BS EN 1021-1 (cigarette)
 BS 476 Part 7, Class 2
 Class Uno UNI 9174 - UNI 8457
 CA TB 117-2013
 ASTM E 84 Class I

Office booth – walls outside, inside – fabric Synergy – third price group

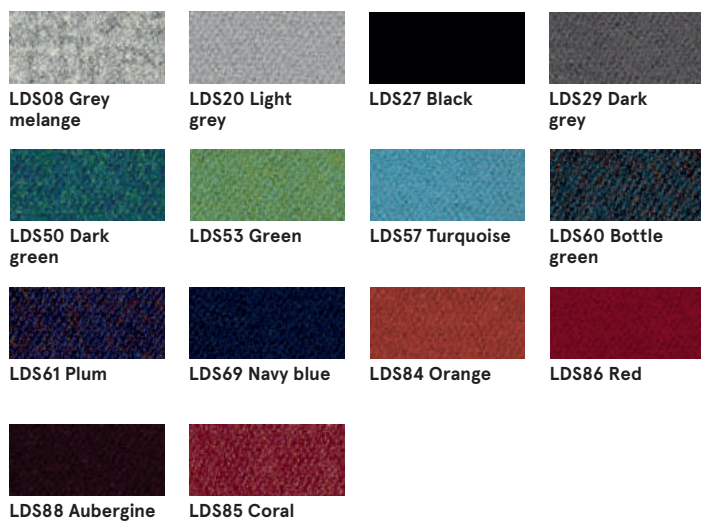

LDS08 Grey melange
LDS20 Light grey
LDS27 Black
LDS29 Dark grey
LDS50 Dark green
LDS53 Green
LDS57 Turquoise
LDS60 Bottle green
LDS61 Plum
LDS69 Navy blue
LDS84 Orange
LDS86 Red
LDS88 Aubergine
LDS85 Coral

Technical data:

Material 95% Virgin Wool, 5% Poliamid
Fabric weight 400g/m2 ±5% (560 g/lin.m ±5%)
Abrasion resistance rubs Independently certified
 ≥100,000 Martindale cycles
Colour fastness to light 5 (ISO 105 - B02)
Colour fastness to rubbing ISO 105 - X12 - wet: 4, dry: 4
Flammability EN 1021 - 1 (cigarette),
 EN 1021 - 2 (match),
 BS 7176 Low Hazard,
 UNI 9175 Classe 1 IM,
 ÖNORM B 3825 & A 3800-1

Frame – metal



M010 Light grey semi-matt RAL7044
M014 Red semi-matt RAL3016
M154 Anthracite semi-matt RAL7043